



LPGS Series-Gel Battery

LPGS12-200(12V200Ah)



Specifications

Rated Voltage	12V	
Nominal Capacity	200Ah (C ₁₀ , 1.80V/cell)	
Dimension	Length	522±2mm (20.6 inches)
	Width	240±2mm (9.45 inches)
	Container Height	218±2mm (8.58 inches)
	Total Height	224±2mm (8.82 inches)
Approx Weight	60.3 Kg (132.9 lbs)	
Terminal	M8	
Container Material	ABS	
Rated Capacity (25°C)	206.0 Ah	(20hr, 10.3A, 1.80V/cell)
	200.0 Ah	(10hr, 20.0A, 1.80V/cell)
	170.0 Ah	(5hr, 34.0A, 1.75V/cell)
	147.6 Ah	(3hr, 49.2A, 1.75V/cell)
	113.9 Ah	(1hr, 113.9A, 1.65V/cell)
Max. Discharge Current	2000A (5s)	
Internal Resistance (25°C)	Approx 3.2mΩ	
Operating Temp. Range	Discharge : -20 ~ 55°C (-4 ~ 131°F)	
	Charge : -20 ~ 40°C (-4 ~ 104°F)	
	Storage : -20 ~ 50°C (-4 ~ 122°F)	
Nominal Operating Temp. Range	25±3°C (77±5°F)	
Cycle Use	Initial Charging Current less than 50.0A. Voltage 14.4V~15.0V at 25°C(77°F)Temp. Coefficient -30mV/°C	
Standby Use	Initial Charging Current less than 50.0A. Voltage 13.5V~13.8V at 25°C(77°F)Temp. Coefficient -20mV/°C	
Effect of temp. to Capacity	40°C (104°F)	103%
	25°C (77°F)	100%
	0°C (32°F)	86%
Self Discharge	LPGS series batteries may be stored for up to 6 months at 25°C(77°F) and then a freshening charge is required. For higher temperatures the time interval will be shorter.	



Layout

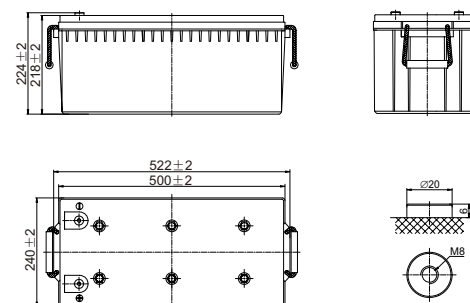

Constant Current Discharge (Amperes) at 25 °C (77°F)

F.V/Time	5min	10min	15min	20min	30min	45min	1h	2h	3h	4h	5h	6h	8h	10h	20h
1.85V/cell	322.4	253.5	215.6	180.3	142.5	108.2	89.5	56.9	44.2	36.4	30.9	26.9	21.9	18.6	10.0
1.80V/cell	426.5	319.2	256.7	210.0	164.0	122.8	99.6	61.9	47.5	38.7	33.2	28.9	23.4	20.0	10.3
1.75V/cell	490.8	358.0	286.1	230.6	174.8	129.9	105.4	64.8	49.2	40.0	34.0	29.7	23.8	20.2	10.4
1.70V/cell	546.8	394.7	309.1	245.2	184.4	136.4	110.0	68.0	50.9	41.2	34.9	30.3	24.1	20.3	10.6
1.65V/cell	597.2	421.9	325.5	258.0	193.1	140.5	113.9	69.9	52.8	42.4	35.7	31.0	24.5	20.5	10.7
1.60V/cell	664.0	461.8	350.9	277.1	205.2	148.5	119.4	72.5	54.7	43.4	36.4	31.6	24.8	20.8	10.8

Constant Power Discharge (Watts/cell) at 25 °C (77°F)

F.V/Time	5min	10min	15min	20min	30min	45min	1h	2h	3h	4h	5h	6h	8h	10h	20h
1.85V/cell	594.1	471.9	405.4	342.5	273.0	209.0	173.5	110.9	86.5	71.3	60.7	53.1	43.4	36.9	19.9
1.80V/cell	778.1	587.6	476.5	393.4	310.4	235.3	192.0	119.9	92.4	75.6	65.0	56.8	46.1	39.7	20.5
1.75V/cell	875.6	647.9	524.3	427.5	328.0	246.8	202.1	125.2	95.5	77.9	66.4	58.2	46.8	40.0	20.6
1.70V/cell	947.0	697.2	557.6	450.4	343.5	257.7	210.1	130.9	98.5	80.0	68.0	59.3	47.4	40.2	21.0
1.65V/cell	1017.5	736.9	581.5	469.4	356.5	263.3	216.1	133.7	101.7	82.1	69.4	60.4	48.0	40.5	21.2
1.60V/cell	1105.2	788.1	616.6	498.6	375.7	276.6	225.4	138.0	104.8	83.7	70.5	61.5	48.5	41.1	21.3



LPGS Series-Gel Battery

LPGS12-200(12V200Ah)



Applications

- Communication power supply
- Engine starting
- Pump systems
- Alarm installations
- Marine and power stations

General Features

- Adopted advantage AGM-GEL technology
- Operation temperature $-20\sim 55^{\circ}\text{C}$
- $\leq 3\%$ Self discharge @ 25°C

Standards

- IEC 60896 Certified
- Classified as "Long Life" according to Eurobat
- UL Certified, CE Certified
- Manufactured in Leoch® IATF16949, ISO 9001, ISO 14001 and ISO 45001 certified production facilities

Discharge Characteristics

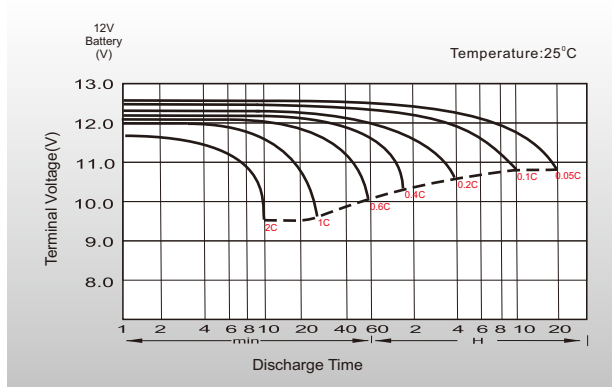

Float Charging Characteristics

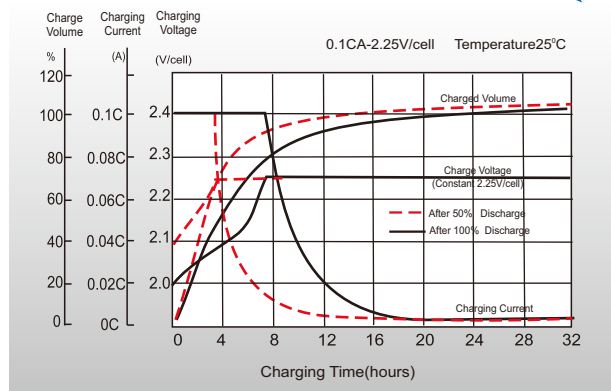

General Relation of Capacity VS. Storage Time

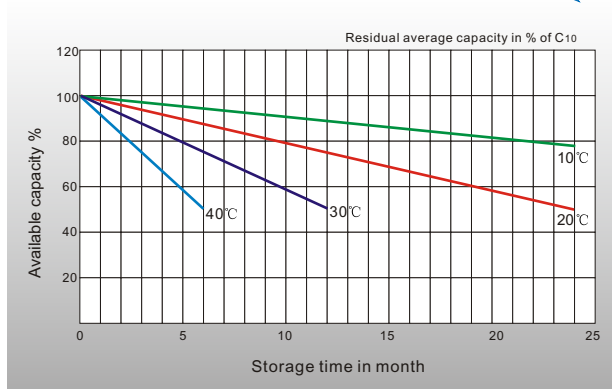

Effect of Temperature on Long Term Float Life

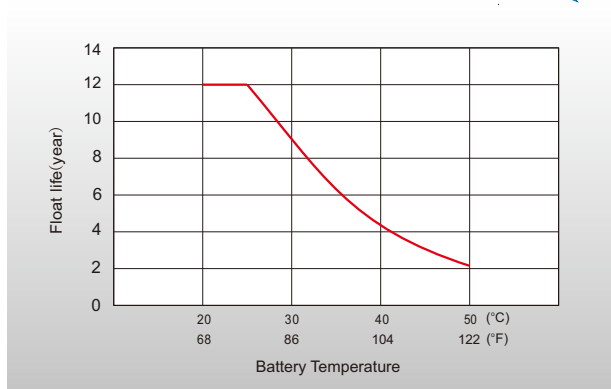

Sales Offices Worldwide

China Sales Office

5th Floor, Xinbaohui Bldg., Nanhai Blvd.,
Nanshan, Shenzhen, China. 518052
Tel: +86-755-86036060 (100 lines)
Fax: +86-755-26067269
E-mail: export@leoch.com

HongKong Sales Office

Workshop C, 33/F, TML Tower, No. 3 Hoi Shing Road,
Tsuen Wan, New Territories, Hong Kong
Tel: +852 35786666
Fax: +44 1452 690125
E-mail: sales.hk@leoch.com

Singapore Sales Office

No. 1 Tech Park Crescent,
Singapore 638131
Tel: +65 68636078
Fax: +65 6863 6079
Email: sales.sg@Leoch.com

Australia Sales Office

2/29 Tarlington Place, Smithfield, NSW 2164
Australia
Tel: 02 9756 0950
E-mail: sales.au@leoch.com

North America Sales Office

19751 Descartes
Foothill Ranch, CA 92610, USA
Tel: 949-588-5853
Fax: 949-588-5966
E-mail: sales@leoch.us

UK Sales Office

9B Wheatstone Court, Waterwells, Business Park,
Gloucester, GL2-2AQ, UK United Kingdom
Tel: +44(0) 1452 729428 / 1452 729696
Fax: +44 1452 690125
E-mail: Sales.Europe@leoch.com

EMEA Sales Office

1 Deligiorgi St., 121 31 Athens,
Greece
Tel: +30 210 5760318 (2 lines)
E-mail: support_EMEA@leoch.com

India Sales Office

Shed no. A-53(b), 2nd Stage of Peenya Industrial Area,
Bangalore North Taluk, Bangalore-560058, India
Tel: +91-80-23440018/23440019
Fax: +91-80-23440017
E-mail: indiasales@leoch.com