

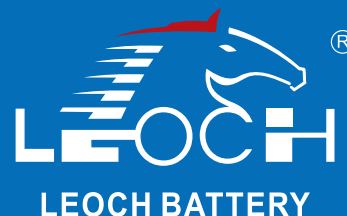

# LPGS Series-Gel Battery

## LPGS12-90(12V90Ah)



### Specifications

Rated Voltage	12V	
Nominal Capacity	90Ah	(C <sub>10</sub> , 1.80V/cell)
Dimension	Length	306±2mm (12.0 inches)
	Width	168±2mm (6.61 inches)
	Container Height	208±2mm (8.19 inches)
	Total Height	214±2mm (8.43 inches)
Approx Weight	27.0 Kg (59.5 lbs)	
Terminal	M6	
Container Material	ABS	
Rated Capacity (25°C)	92.8 Ah	(20hr, 4.64A, 1.80V/cell)
	90.0 Ah	(10hr, 9.00A, 1.80V/cell)
	76.5 Ah	(5hr, 15.3A, 1.75V/cell)
	66.3 Ah	(3hr, 22.1A, 1.75V/cell)
	51.5 Ah	(1hr, 51.3A, 1.65V/cell)
Max. Discharge Current	900A (5s)	
Internal Resistance (25°C)	Approx 5.5mΩ	
Operating Temp. Range	Discharge : -20 ~ 55°C (-4 ~ 131°F)	
	Charge : -20 ~ 40°C (-4 ~ 104°F)	
	Storage : -20 ~ 50°C (-4 ~ 122°F)	
Nominal Operating Temp. Range	25±3°C (77±5°F)	
Cycle Use	Initial Charging Current less than 22.5A. Voltage 14.4V~15.0V at 25°C(77°F)Temp. Coefficient -30mV/°C	
Standby Use	Initial Charging Current less than 22.5A. Voltage 13.5V~13.8V at 25°C(77°F)Temp. Coefficient -20mV/°C	
Effect of temp. to Capacity	40°C (104°F)	103%
	25°C (77°F)	100%
	0°C (32°F)	86%
Self Discharge	LPGS series batteries may be stored for up to 6 months at 25°C(77°F) and then a freshening charge is required. For higher temperatures the time interval will be shorter.	

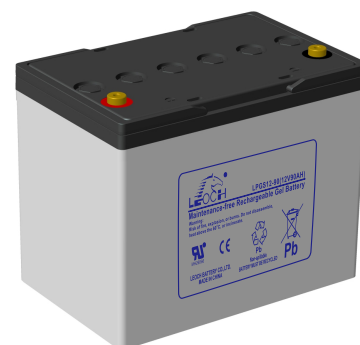

### Layout

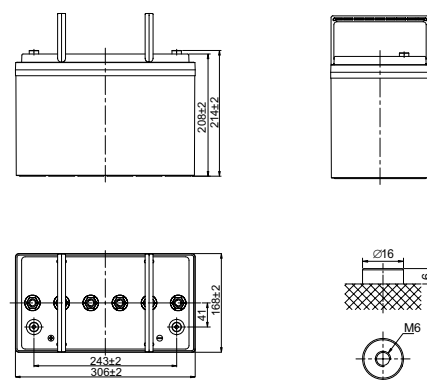

### Constant Current Discharge (Amperes) at 25 °C (77°F)

F.V/Time	5min	10min	15min	20min	30min	45min	1h	2h	3h	4h	5h	6h	8h	10h	20h
1.85V/cell	145.1	114.1	97.0	81.2	64.1	48.7	40.3	25.7	19.9	16.4	13.9	12.2	9.90	8.35	4.50
1.80V/cell	192.0	143.6	115.5	94.5	73.8	55.3	44.8	27.8	21.4	17.5	14.9	13.0	10.5	9.00	4.64
1.75V/cell	220.9	161.1	128.8	103.8	78.7	58.4	47.4	29.2	22.1	18.0	15.3	13.3	10.7	9.09	4.68
1.70V/cell	246.1	177.7	139.1	110.3	83.0	61.4	49.5	30.6	23.0	18.5	15.8	13.7	10.8	9.18	4.77
1.65V/cell	268.7	189.8	146.4	116.1	86.9	63.2	51.3	31.4	23.8	19.1	16.1	14.0	11.0	9.27	4.82
1.60V/cell	298.8	207.8	158.0	124.7	92.3	66.9	53.7	32.6	24.6	19.5	16.4	14.2	11.2	9.36	4.86

### Constant Power Discharge (Watts/cell) at 25 °C (77°F)

F.V/Time	5min	10min	15min	20min	30min	45min	1h	2h	3h	4h	5h	6h	8h	10h	20h
1.85V/cell	267.3	212.3	182.4	154.1	122.9	94.1	78.1	49.9	38.9	32.1	27.4	23.9	19.5	16.6	8.95
1.80V/cell	350.1	264.4	214.5	177.0	139.7	105.9	86.4	53.9	41.6	34.0	29.3	25.6	20.8	17.8	9.18
1.75V/cell	394.0	291.6	236.0	192.3	147.6	111.1	91.0	56.3	42.9	35.0	29.9	26.2	21.1	18.0	9.27
1.70V/cell	426.2	313.7	250.9	202.7	154.6	116.0	94.5	59.0	44.3	36.0	30.6	26.6	21.3	18.1	9.45
1.65V/cell	457.9	331.6	261.6	211.2	160.4	118.5	97.3	60.2	45.8	36.9	31.2	27.2	21.6	18.3	9.54
1.60V/cell	497.3	354.7	277.5	224.4	169.0	124.5	101.4	62.1	47.2	37.6	31.7	27.7	21.9	18.5	9.63



# LPGS Series-Gel Battery

## LPGS12-90(12V90Ah)

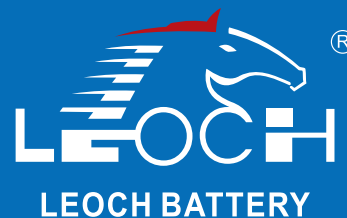

### Applications

- Communication power supply
- Engine starting
- Pump systems
- Alarm installations
- Marine and power stations

### General Features

- Adopted advantage AGM-GEL technology
- Operation temperature  $-20\sim 55^{\circ}\text{C}$
- $\leq 3\%$  Self discharge @ $25^{\circ}\text{C}$

### Standards

- IEC 60896 Certified
- Classified as "Long Life" according to Eurobat
- UL Certified, CE Certified
- Manufactured in Leoch® IATF16949, ISO 9001, ISO 14001 and ISO 45001 certified production facilities

### Discharge Characteristics

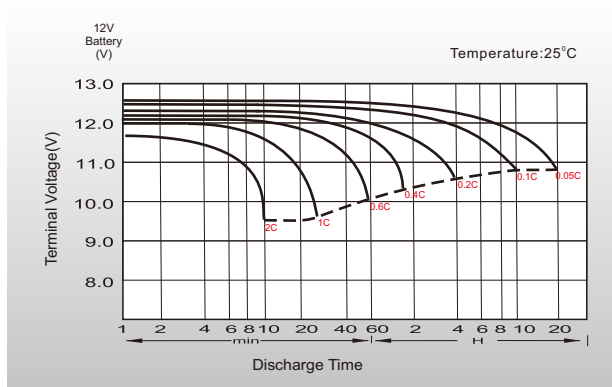

### Float Charging Characteristics

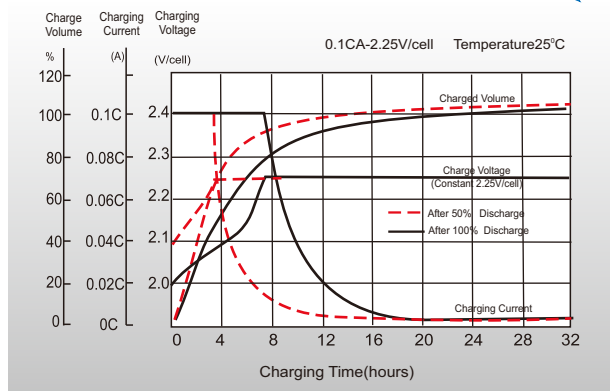

### General Relation of Capacity VS. Storage Time

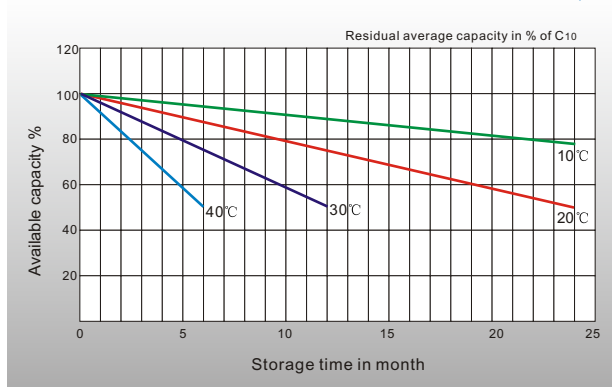

### Effect of Temperature on Long Term Float Life

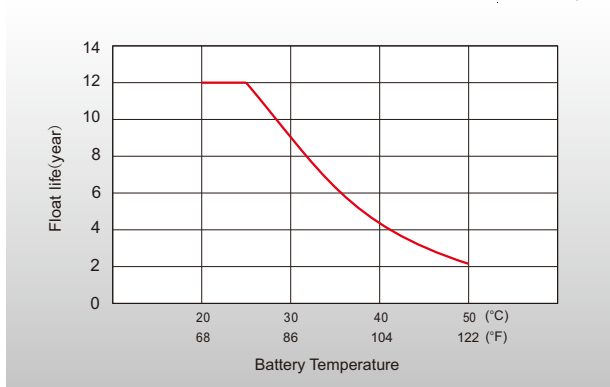

### Sales Offices Worldwide

#### China Sales Office

5th Floor, Xinbaohui Bldg., Nanhai Blvd.,  
Nanshan, Shenzhen, China. 518052  
Tel: +86-755-86036060 (100 lines)  
Fax: +86-755-26067269  
E-mail: export@leoch.com

#### HongKong Sales Office

Workshop C, 33/F, TML Tower, No. 3 Hoi Shing Road,  
Tsuen Wan, New Territories, Hong Kong  
Tel: +852 35786666  
Fax: +44 1452 690125  
E-mail: sales.hk@leoch.com

#### Singapore Sales Office

No. 1 Tech Park Crescent,  
Singapore 638131  
Tel: +65 68636078  
Fax: +65 6863 6079  
Email: sales.sg@Leoch.com

#### Australia Sales Office

2/29 Tarlington Place, Smithfield, NSW 2164  
Australia  
Tel: 02 9756 0950  
E-mail: sales.au@leoch.com

#### North America Sales Office

19751 Descartes  
Foothill Ranch, CA 92610, USA  
Tel: 949-588-5853  
Fax: 949-588-5966  
E-mail: sales@leoch.us

#### UK Sales Office

9B Wheatstone Court, Waterwells, Business Park,  
Gloucester, GL2-2AQ, UK United Kingdom  
Tel: +44(0) 1452 729428 / 1452 729696  
Fax: +44 1452 690125  
E-mail: Sales.Europe@leoch.com

#### EMEA Sales Office

1 Deligiorgi St., 121 31 Athens,  
Greece  
Tel: +30 210 5760318 (2 lines)  
E-mail: support\_EMEA@leoch.com

#### India Sales Office

Shed no. A-53(b), 2nd Stage of Peenya Industrial Area,  
Bangalore North Taluk, Bangalore-560058, India  
Tel: +91-80-23440018/23440019  
Fax: +91-80-23440017  
E-mail: indiasales@leoch.com