

Specification

Nominal Voltage	6V	
Nominal Capacity(20HR)	4.5AH	
Dimensions	Length	67±1mm (2.64 inches)
	Width	67±1mm (2.64 inches)
	Container Height	96±1mm (3.78 inches)
	Total Height (with Terminal)	109±2mm (4.29 inches)
Approx Weight	Approx 0.78 kg (1.72lbs)	
Terminal	Spring Terminal	
Container Material	ABS	
Rated Capacity	4.50 AH/0.225A	(20hr, 1.80V/cell, 25°C/77°F)
	4.19 AH/0.419A	(10hr, 1.80V/cell, 25°C/77°F)
	3.78 AH/0.756A	(5hr, 1.75V/cell, 25°C/77°F)
	3.30 AH/1.10A	(3hr, 1.75V/cell, 25°C/77°F)
	2.73 AH/2.73A	(1hr, 1.60V/cell, 25°C/77°F)
Max. Discharge Current	67.5A (5s)	
Internal Resistance	Approx 150mΩ	
Operating Temp. Range	Discharge	-15~50°C (5~122°F)
	Charge	0~40°C (32~104°F)
	Storage	-15~40°C (5~104°F)
Nominal Operating Temp. Range	25±3°C (77±5°F)	
Cycle Use	Initial Charging Current less than 1.35A. Voltage	
	7.2V~7.5V at 25°C(77°F)Temp. Coefficient -15mV/°C	
Standby Use	No limit on Initial Charging Current Voltage	
	6.75V~6.9V at 25°C(77°F)Temp. Coefficient -10mV/°C	
Capacity affected by Temperature	40°C (104°F)	103%
	25°C (77°F)	100%
	0°C (32°F)	86%
Self Discharge	Leoch LP series batteries may be stored for up to 6 months at 25°C(77°F) and then a freshening charge is required. For higher temperatures the time interval will be shorter.	



Applications

- ◆ All purpose
- ◆ Uninterruptable Power Supply (UPS)
- ◆ Electric Power System (EPS)
- ◆ Emergency backup power supply
- ◆ Emergency light
- ◆ Railway signal
- ◆ Aircraft signal
- ◆ Alarm and security system
- ◆ Electronic apparatus and equipment
- ◆ Communication power supply
- ◆ DC power supply
- ◆ Auto control system



Constant Current Discharge (Amperes) at 25 °C (77°F)

F.V/Time	5min	10min	15min	20min	30min	45min	1h	2h	3h	4h	5h	6h	8h	10h	20h
1.85V/cell	8.64	6.02	4.97	4.31	3.46	2.66	2.17	1.33	1.01	0.831	0.706	0.611	0.486	0.404	0.223
1.80V/cell	10.6	7.19	5.76	4.87	3.83	2.90	2.34	1.41	1.06	0.874	0.736	0.638	0.504	0.419	0.225
1.75V/cell	12.6	8.13	6.35	5.31	4.09	3.08	2.46	1.47	1.10	0.901	0.756	0.654	0.518	0.427	0.227
1.70V/cell	14.3	8.96	6.88	5.70	4.29	3.20	2.57	1.53	1.14	0.924	0.775	0.670	0.525	0.434	0.231
1.65V/cell	15.7	9.64	7.27	5.98	4.47	3.32	2.67	1.58	1.17	0.943	0.792	0.683	0.534	0.440	0.234
1.60V/cell	16.5	10.0	7.58	6.17	4.60	3.40	2.73	1.63	1.19	0.966	0.808	0.696	0.545	0.447	0.236

Constant Power Discharge (Watts/cell) at 25 °C (77°F)

F.V/Time	5min	10min	15min	20min	30min	45min	1h	2h	3h	4h	5h	6h	8h	10h	20h
1.85V/cell	16.3	11.5	9.55	8.35	6.74	5.21	4.28	2.63	2.01	1.66	1.41	1.23	0.977	0.815	0.450
1.80V/cell	19.8	13.6	11.0	9.37	7.41	5.65	4.58	2.78	2.10	1.73	1.46	1.27	1.01	0.838	0.452
1.75V/cell	23.2	15.2	12.0	10.1	7.86	5.96	4.80	2.88	2.16	1.78	1.49	1.30	1.03	0.849	0.453
1.70V/cell	26.0	16.6	12.9	10.8	8.20	6.16	4.97	2.98	2.22	1.81	1.52	1.32	1.04	0.858	0.459
1.65V/cell	28.3	17.6	13.4	11.2	8.48	6.36	5.15	3.05	2.27	1.84	1.55	1.34	1.05	0.866	0.463
1.60V/cell	29.2	18.1	13.9	11.4	8.62	6.44	5.22	3.13	2.31	1.87	1.57	1.36	1.07	0.876	0.464

Specifications subject to change without notice.



Dimensions

Spring Terminal

Unit: mm [inches]

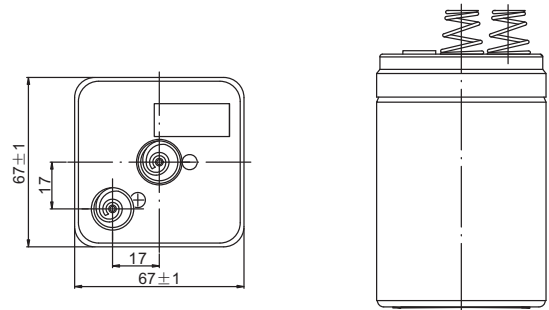
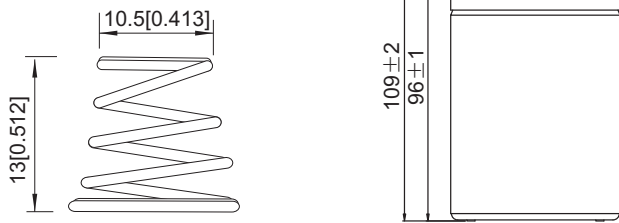

Discharge Characteristics

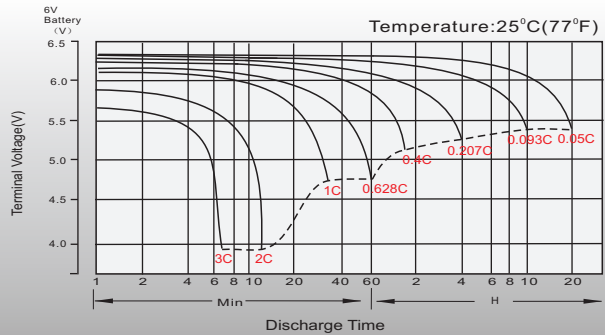

Float Charging Characteristics

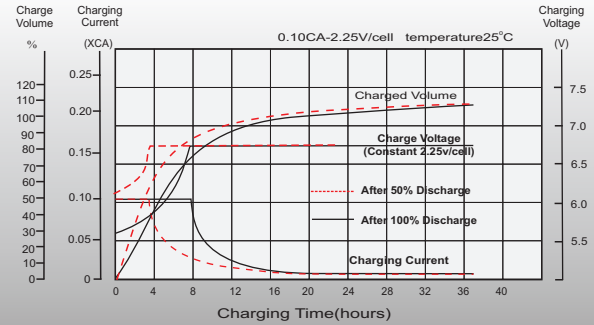

Temperature Effects in Relation to Battery Capacity

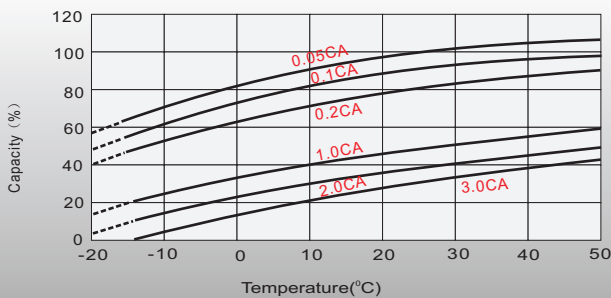

Effect of Temperature on Long Term Float Life

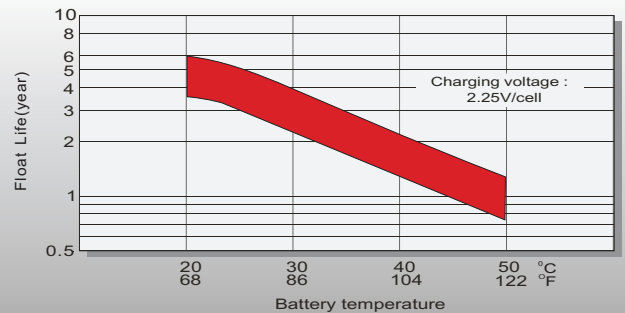

Cycle Life in Relation to Depth of Discharge

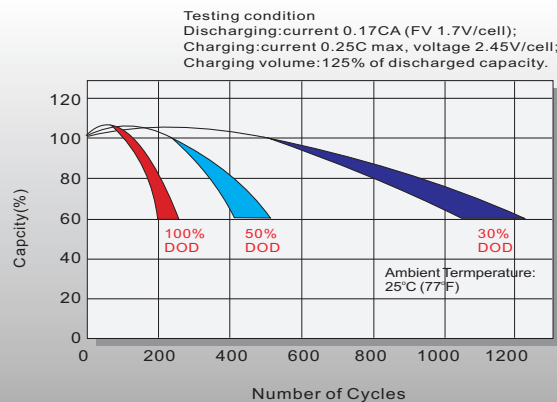

Self Discharge Characteristics

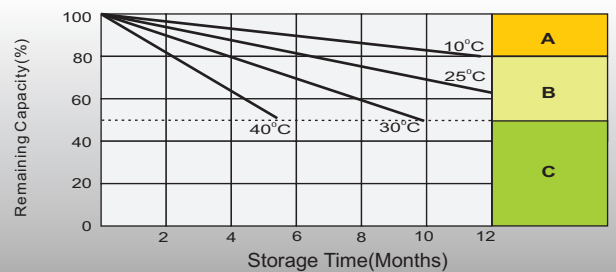

A No supplementary charge required (Carry out supplementary charge before use if 100% capacity is required.)

Supplementary charge required before use. Optional charging way as below:
B 1. Charged for above 3 days at limited current 0.25CA and constant voltage 2.25V/cell.
 2. Charged for above 20 hours at limited current 0.25CA and constant voltage 2.45V/cell.
 3. Charged for 8-10 hours at limited current 0.05CA.

C Supplementary charge may often fail to recover the capacity. The battery should never be left standing till this is reached.

Sales Office

China sales office:

Add: 5th Floor, Xinbaohui Bldg., Nanhai Blvd.,
 Nanshan, Shenzhen, China. 518052
 Tel: +86-755-86036060 (100 lines)
 Fax: +86-755-26067269
 E-mail: export@leoch.com
 Http://www.leoch.com

HongKong sales office:

Workshop C, 33/F, TML Tower,
 No. 3 Hoi Shing Road, Tsuen Wan,
 New Territories, Hong Kong
 Tel: +852 35786666
 Fax: +852 21170016
 E-mail: sales.hk@leoch.com

Singapore sales office:

Add: No. 1 Tech Park Crescent,
 Singapore 638131
 Tel: +65 68636078
 Fax: +65 68636079
 Email sales.sg@leoch.com
 Http://www.leoch.com

North America sales office:

Add: 19751 Descartes, Unit A,
 Foothill Ranch, CA 92610, USA
 Tel: 949-588-5853
 Fax: 949-588-5966
 E-mail: sales@leoch.us
 Http://www.leoch.com

Europe sales office:

Add: 9B Wheatstone Court. Waterwells
 Business Park, Gloucester, GL2-2AQ,
 UK United Kingdom
 Tel: +44(0) 1452 729428 / 1452 729696
 Fax: +44 (0)1452-690125
 E-mail: Sales.Europe@leoch.com