



LPF Series-Front Terminal

LPF12-55(12V55Ah)



Specifications

Rated Voltage	12V	
Nominal Capacity	$C_{10}, 1.80V/cell$	55.0Ah
Dimension	Length	277±2mm (10.9 inches)
	Width	106±2mm (4.17 inches)
	Container Height	222±2mm (8.74 inches)
	Total Height	222±2mm (8.74 inches)
Approx Weight	17.3 Kg (38.2 lbs)	
Terminal	M6	
Container Material	ABS	
Rated Capacity (25°C)	58.2 Ah	(20hr, 2.91A, 1.80V/cell)
	55.0 Ah	(10hr, 5.50A, 1.80V/cell)
	53.6 Ah	(8hr, 6.70A, 1.75V/cell)
	48.2 Ah	(5hr, 9.64A, 1.75V/cell)
	36.4 Ah	(1hr, 36.4A, 1.60V/cell)
Max. Discharge Current	550A (5s)	
Internal Resistance (25°C)	Approx 7.6mΩ	
Operating Temp. Range	Discharge	-15 ~ 50°C (5 ~ 122°F)
	Charge	-20 ~ 40°C (-4 ~ 104°F)
	Storage	-15 ~ 40°C (5 ~ 104°F)
Nominal Operating Temp. Range	25±3°C (77±5°F)	
Cycle Use	Initial Charging Current less than 15.0A. Voltage 14.1V~14.4V at 25°C(77°F)Temp. Coefficient -30mV/°C	
	Initial Charging Current less than 15.0A. Voltage 13.5V~13.8V at 25°C(77°F)Temp. Coefficient -20mV/°C	
Standby Use	Initial Charging Current less than 15.0A. Voltage 13.5V~13.8V at 25°C(77°F)Temp. Coefficient -20mV/°C	
Effect of temp. to Capacity	40°C (104°F)	103%
	25°C (77°F)	100%
	0°C (32°F)	86%
Self Discharge	LPF series batteries may be stored for up to 6 months at 25°C(77°F) and then a freshening charge is required. For higher temperatures the time interval will be shorter.	



Layout

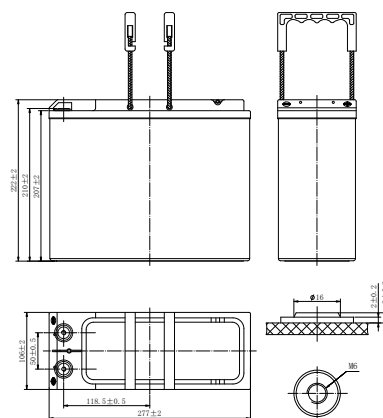

Constant Current Discharge (Amperes) at 25 °C (77°F)

F.V/Time	10min	15min	20min	30min	45min	1h	2h	3h	4h	5h	6h	8h	10h	20h
1.85V/cell	87.8	76.2	65.9	51.7	39.4	31.7	18.3	13.3	10.7	8.97	7.86	6.30	5.26	2.79
1.80V/cell	101.3	86.0	73.0	56.6	42.5	33.9	19.7	14.3	11.3	9.52	8.29	6.62	5.50	2.91
1.75V/cell	111.9	93.1	78.9	59.5	43.9	34.9	20.1	14.5	11.5	9.64	8.39	6.70	5.56	2.93
1.70V/cell	118.1	98.3	82.0	61.2	44.9	35.5	20.4	14.7	11.6	9.73	8.46	6.75	5.60	2.95
1.67V/cell	123.4	102.1	84.5	62.2	45.5	35.9	20.5	14.8	11.7	9.82	8.53	6.81	5.64	2.97
1.60V/cell	128.7	104.9	86.3	63.5	46.1	36.4	20.7	14.9	11.8	9.90	8.61	6.86	5.68	2.99

Constant Power Discharge (Watts/cell) at 25 °C (77°F)

F.V/Time	10min	15min	20min	30min	45min	1h	2h	3h	4h	5h	6h	8h	10h	20h
1.85V/cell	167.2	146.5	127.8	100.9	77.2	62.4	36.3	26.5	21.3	17.9	15.8	12.7	10.6	5.63
1.80V/cell	191.6	164.4	140.6	109.9	82.9	66.5	38.9	28.3	22.6	19.0	16.6	13.3	11.1	5.87
1.75V/cell	210.0	176.5	151.1	114.9	85.5	68.3	39.6	28.8	22.9	19.2	16.8	13.4	11.2	5.90
1.70V/cell	218.8	184.6	155.6	117.3	86.7	69.2	39.9	28.9	23.0	19.3	16.9	13.5	11.2	5.93
1.67V/cell	225.1	188.8	158.3	117.8	87.2	69.3	40.0	29.0	23.1	19.4	17.0	13.6	11.3	5.95
1.60V/cell	229.8	190.9	159.6	119.0	87.5	69.8	40.2	29.1	23.2	19.5	17.1	13.7	11.3	5.98



LPF Series-Front Terminal

LPF12-55(12V55Ah)



Applications

- UPS
- For standard power cabinet
- Network connection equipment of communication system
- Power system of special network of local area network
- Power station systems

General Features

- 12 years design life(25°C)
- Specifically ideal for 19 inches or 23 inches power cabinets
- Front terminals make the installation, maintenance and supervision easy
- Shield designs protect terminals from short circuit and show good appearance
- Unique vent valve design: reduce water losing and prevent air/spark going inside

Standards

- Compliance with IEC 60896 standards, EU Battery Directive
- UL, CE Certified
- Manufactured in Leoch@IATF16949, ISO 45001, ISO 9001 and ISO 14001 certified production facilities

Discharge Characteristics

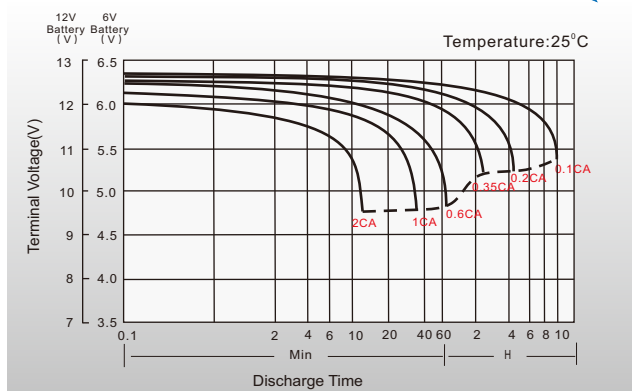

Float Charging Characteristics

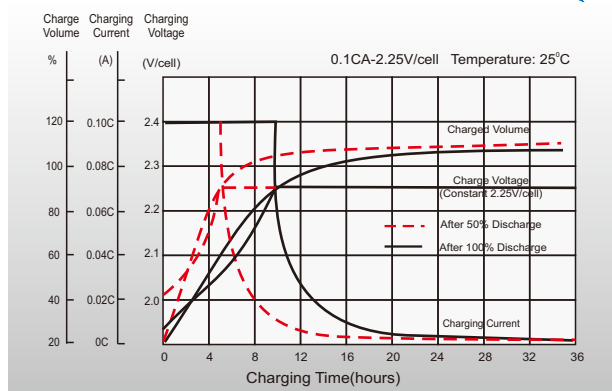

Temperature Effects in Relation to Battery Capacity

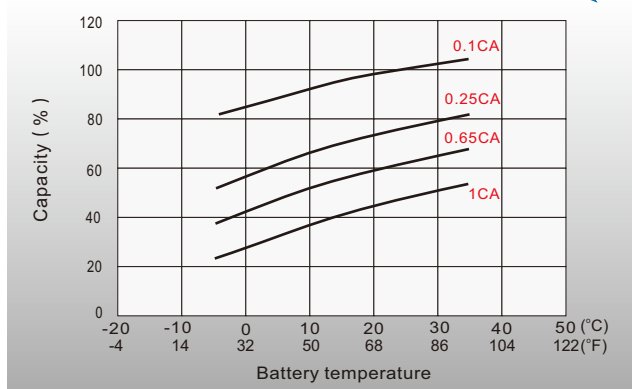

Effect of Temperature on Long Term Float Life

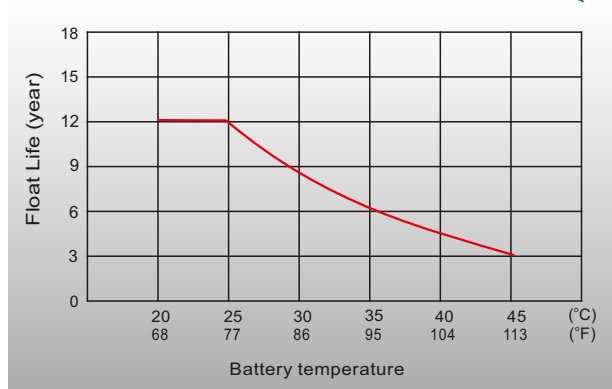

Sales Offices Worldwide

China Sales Office

5th Floor, Xinbaohui Bldg., Nanhai Blvd.,
Nanshan, Shenzhen, China. 518052
Tel: +86-755-86036060 (100 lines)
Fax: +86-755-26067269
E-mail: export@leoch.com

HongKong Sales Office

Workshop C, 33/F, TML Tower, No. 3 Hoi Shing Road,
Tsuen Wan, New Territories, Hong Kong
Tel: +852 35786666
Fax: +44 1452 690125
E-mail: sales.hk@leoch.com

Singapore Sales Office

No. 1 Tech Park Crescent,
Singapore 638131
Tel: +65 68636078
Fax: +65 6863 6079
Email: sales.sg@Leoch.com

Australia Sales Office

2 /29 Tarlington Place, Smithfield. NSW 2164
Australia
Tel: 02 9756 0950
E-mail: sales.au@leoch.com

North America Sales Office

19751 Descartes
Foothill Ranch, CA 92610, USA
Tel: 949-588-5853
Fax: 949-588-5966
E-mail: sales@leoch.us
Http://www.leoch.us

UK Sales Office

9B Wheatstone Court. Waterwells, Business Park,
Gloucester, GL2-2AQ, UK United Kingdom
Tel: +44(0) 1452 729428 / 1452 729696
Fax: +44 1452 690125
E-mail: Sales.Europe@leoch.com
Http://www.leoch.eu

EMEA Sales Office

1 Deligiorgi St., 121 31 Athens,
Greece
Tel: +30 210 5760318 (2 lines)
E-mail: support_EMEA@leoch.com
Http://www.leoch.eu

India Sales Office

Shed no.A-53(b), 2nd Stage of Peenya Industrial Area,
Bangalore North Taluk, Bangalore-560058, India
Tel: +91-80-23440018/23440019
Fax: +91-80-23440017
E-mail: indiasales@leoch.com



[Http://www.leoch.com](http://www.leoch.com)

© 2020 LEOCH. All rights reserved.

Trademarks and logos are the property of LEOCH and its affiliates unless otherwise noted.
Subject to revisions without prior notice.

Publication No.: LB-LPF12-55-PD-EN-V2.0-202004