

LPG SERIES-GEL Battery

LPG2-100 (2V96AH)

Specification

Nominal Voltage	2V	
Nominal Capacity(20HR)	96.0AH	
Dimension	Length	170±2mm (6.69 inches)
	Width	72±1mm (2.83 inches)
	Container Height	205±3mm (8.07 inches)
	Total Height (with Terminal)	214±3mm (8.35 inches)
Approx Weight	Approx 6.0 kg (13.23lbs)	
Terminal	T6	
Container Material	ABS	
Rated Capacity	96.0 AH/4.80A	(20hr, 1.80V/cell, 25°C/77°F)
	90.0 AH/9.00A	(10hr, 1.75V/cell, 25°C/77°F)
	77.5 AH/15.5A	(5hr, 1.75V/cell, 25°C/77°F)
	69.0 AH/23.0A	(3hr, 1.75V/cell, 25°C/77°F)
	52.8 AH/52.8A	(1hr, 1.67V/cell, 25°C/77°F)
Max. Discharge Current	700A (5s)	
Internal Resistance	Approx 1.68mΩ	
Operating Temp. Range	Discharge	-20~55°C (-4~131°F)
	Charge	0~40°C (32~104°F)
	Storage	-20~50°C (-4~122°F)
Nominal Operating Temp. Range	25±3°C (77±5°F)	
Cycle Use	Initial Charging Current less than 24.0A. Voltage	
	2.4V~2.5V at 25°C(77°F)Temp. Coefficient -5mV/°C	
Standby Use	No limit on Initial Charging Current Voltage	
	2.25V~2.3V at 25°C(77°F)Temp. Coefficient -3mV/°C	
Capacity affected by Temperature	40°C (104°F)	103%
	25°C (77°F)	100%
	0°C (32°F)	86%
Self Discharge	Leoch LPG series batteries may be stored for up to 9 months at 25°C(77°F) and then a freshening charge is required. For higher temperatures the time interval will be shorter.	



Applications

- ◆ Telecommunications
- ◆ Solar system
- ◆ Wind power system
- ◆ Wheelchair
- ◆ Floor cleaning machines
- ◆ Golf trolley
- ◆ Boats

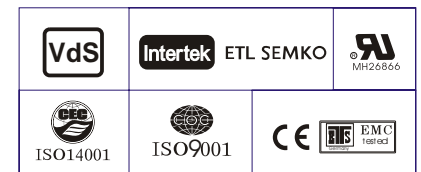

Constant Current Discharge (Amperes) at 25 °C (77°F)

F.V/Time	20min	30min	45min	1h	2h	3h	4h	5h	6h	7h	8h	9h	10h	20h
1.85V/cell	74.5	64.6	51.7	41.6	27.3	20.9	17.2	14.7	12.8	11.2	10.3	9.38	8.67	4.66
1.80V/cell	88.1	75.9	58.9	46.6	29.6	21.7	17.9	15.1	13.1	11.4	10.6	9.65	8.91	4.80
1.75V/cell	96.4	79.4	62.6	49.0	30.7	23.0	18.3	15.5	13.5	11.7	10.8	9.81	9.00	4.87
1.70V/cell	102.7	83.3	65.3	50.9	32.0	23.7	18.9	15.9	13.9	12.2	11.2	10.1	9.19	4.92
1.67V/cell	110.5	88.7	67.1	52.8	32.9	24.7	19.7	16.4	14.3	12.4	11.4	10.3	9.39	4.97
1.60V/cell	119.3	94.5	70.2	54.9	34.0	25.5	20.4	16.7	14.5	12.6	11.5	10.5	9.60	5.03

Constant Power Discharge (Watts) at 25 °C (77°F)

F.V/Time	20min	30min	45min	1h	2h	3h	4h	5h	6h	7h	8h	9h	10h	20h
1.85V/cell	139.6	122.8	99.5	80.5	52.8	40.7	33.6	28.8	25.1	22.2	20.3	18.5	17.2	9.22
1.80V/cell	163.3	142.1	111.9	89.6	57.1	42.1	34.7	29.4	25.6	22.4	20.8	19.0	17.6	9.49
1.75V/cell	177.1	147.8	118.2	93.7	59.1	44.4	35.5	30.1	26.3	22.9	21.2	19.3	17.8	9.62
1.70V/cell	187.5	154.0	122.9	96.9	61.3	45.6	36.5	30.9	27.2	23.9	22.0	19.8	18.1	9.72
1.67V/cell	200.2	162.6	125.1	99.8	62.7	47.5	37.9	31.7	27.9	24.2	22.2	20.2	18.5	9.81
1.60V/cell	213.9	172.3	130.2	103.2	64.6	48.8	39.2	32.2	28.2	24.5	22.5	20.6	18.9	9.90



Dimensions

T6 Terminal

Unit: mm [inches]

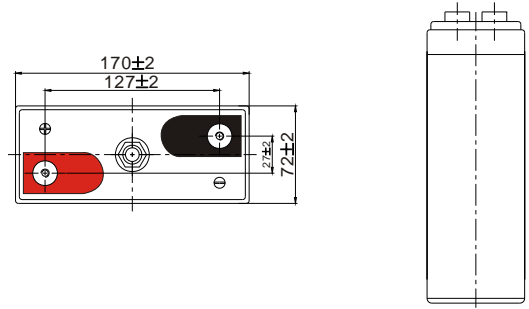
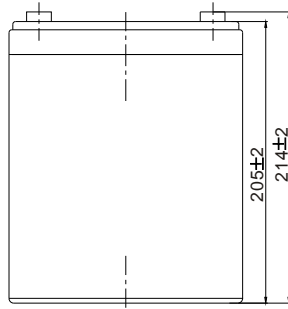
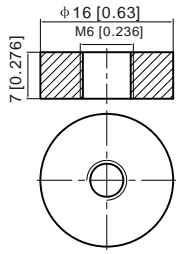

Discharge Characteristics

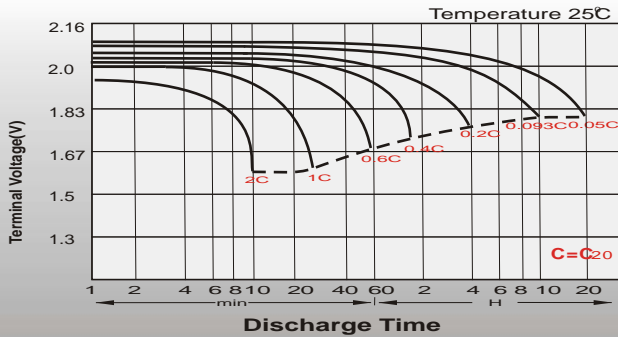

Float Charging Characteristics

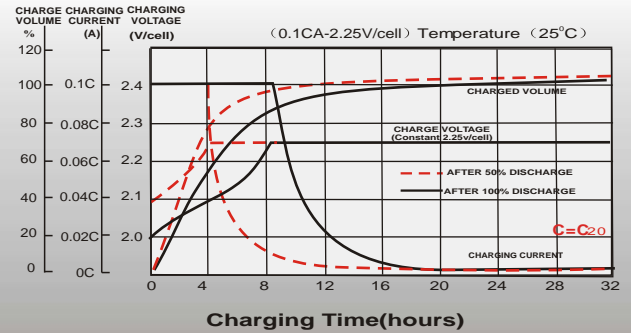

Temperature Effects in Relation to Battery Capacity

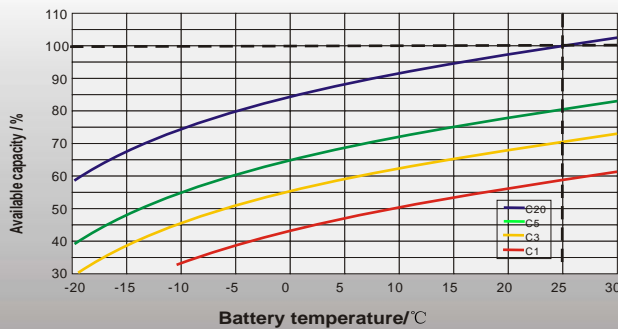

Effect of Temperature on Long Term Float Life

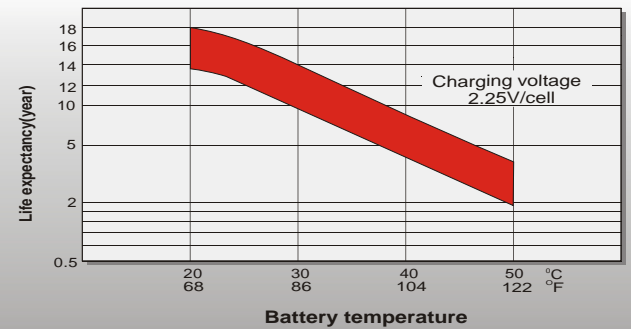

Cycle Life in Relation to Depth of Discharge

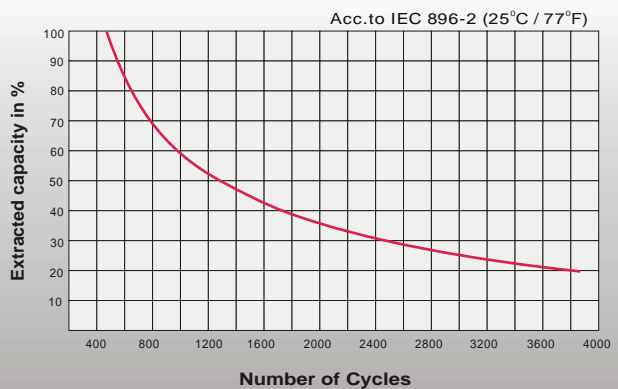

General Relation of Capacity VS. Storage Time

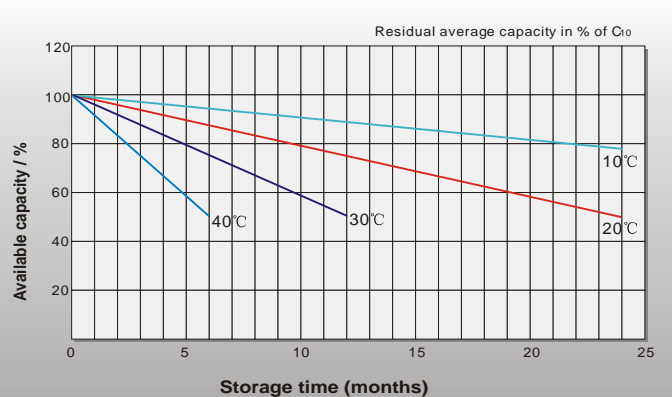

Sales Office

China sales office:

Add: 5th Floor, Xinbaohui Bldg., Nanhai Blvd.,
Nanshan, Shenzhen, China. 518052
Tel: +86-755-86036060 (100 lines)
Fax: +86-755-26067269
E-mail: export@leoch.com
Http://www.leoch.com

HongKong sales office:

Add: Workshop C, 33/F, TML Tower,
No. 3 Hoi Shing Road, Tsuen Wan,
New Territories, Hong Kong
Tel: +852 35786666
Fax: +852 21170016
E-mail: sales.hk@leoch.com

Singapore sales office:

Add: No. 1 Tech Park Crescent,
Singapore 638131
Tel: +65 68416629
Fax: +65 68443210
Email: sales.sg@Leoch.com

North America sales office:

Add: 19751 Descartes, Unit A,
Foothill Ranch, CA 92610, USA
Tel: 949-588-5853
Fax: 949-588-5966
E-mail: sales@leoch.us
Http://www.leoch.com

Europe sales office:

Add: 9B Wheatstone Court, Waterwells
Business Park, Gloucester, GL2-2AQ,
UK United Kingdom
Tel: +44(0) 1452 729428 / 1452 729696
E-mail: +44 (0)1452-690125
E-mail: Sales.Europe@leoch.com