

MARINE AGM DUAL PURPOSE BATTERY

LPM12-140M (12V140Ah)



CHARACTERISTICS

Item	Specifications	
Nominal Voltage	12V	
Nominal Capacity (20HR)	140Ah	
Reserve Capacity	247min	
Cold Cranking Amps@0°F (-18°C)	700A	
Dimension	Length	512mm (20.2inches)
	Width	188mm (7.40inches)
	Height	218mm (8.58inches)
Approx Weight	41.2kg (90.8lbs)	
Terminal	1	
Cell layout	3	
Hold-Down	B0	
Case	Black-PP Material	
Cover	Black-PP Material	
Handle	TS8	

APPLICATIONS

- MARINE and RV
- Start and deep cycle

GENERAL FEATURES

- Superior starting and cycling performance
- High capacity and high CCA
- 2x faster charge acceptance than conventional starter batteries
- 3x higher cycle life than conventional starter batteries
- Advanced Absorbed Glass Mat (AGM) technology

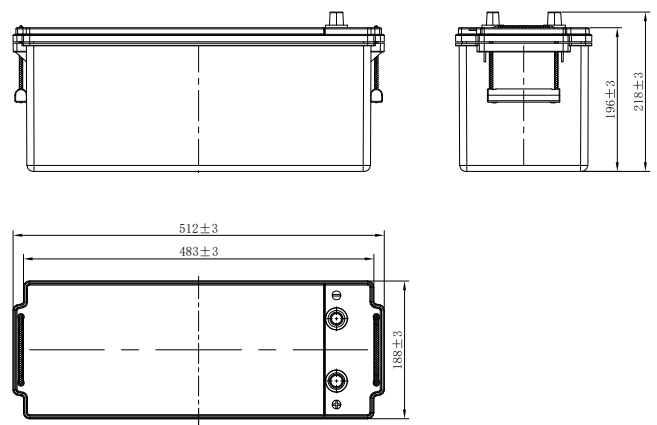
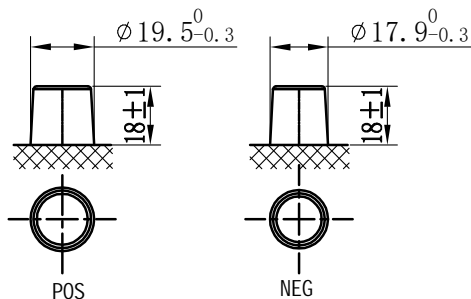

*Values are subject to variation of +/- 5% in normal manufacturing processes.

Leoch International Technology Ltd.
www.leoch.com

Leoch Batteries Pte Ltd
www.leoch.sg

Leoch Battery Corporation
www.leochamericas.com

Leoch Europe S.A.
www.leoch.eu