

AGM START-STOP BATTERY

AGM-L2 (12V60Ah)



CHARACTERISTICS

Item	Specifications	
Nominal Voltage	12V	
Nominal Capacity (20HR)	60Ah	
Reserve Capacity	100min	
Cold Cranking Amps@0°F (-18°C)	680A	
Dimension	Length	242mm (9.53inches)
	Width	175mm (6.89inches)
	Container Height	190mm (7.48inches)
	Total Height (with Terminal)	190mm (7.48inches)
Approx Weight	18.6kg (41.0lbs)	
Terminal	1	
Cell layout	0	
Hold-Down	B13	
Case	Black-PP Material	
Cover	Black-PP Material	
Handle	TS2	

APPLICATIONS

- Car with start-stop system
- EV/HEV
- Engine start

GENERAL FEATURES

- Maximum CCA and life
- Valve regulated technology
- Advanced Absorbed Glass Mat (AGM) technology
- Top-level safety - absolutely no free acid
- 2x Faster Charge Acceptance than conventional starter batteries
- 3x higher cycle life than conventional starter batteries
- Suit for working in partial state of charge operations (PSoC)
- OE quality certification

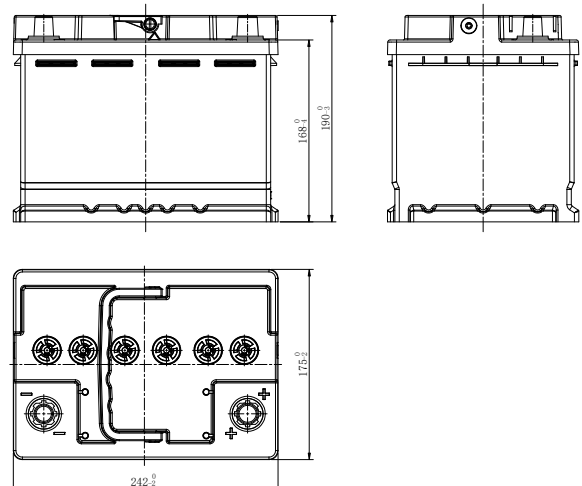
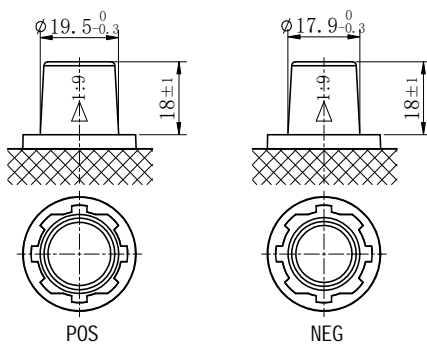

*Values are subject to variation of +/- 5% in normal manufacturing processes.

Leoch International Technology Ltd.
www.leoch.com

Leoch Batteries Pte Ltd
www.leoch.sg

Leoch Battery Corporation
www.leochamericas.com

Leoch Europe S.A.
www.leoch.eu