

FLOODED BATTERY

31A-950 (12V105Ah)



CHARACTERISTICS

Item	Specifications	
Nominal Voltage	12V	
Nominal Capacity (20HR)	105Ah	
Reserve Capacity	190min	
Cold Cranking Amps@0°F (-18°C)	950A	
Dimension	Length	329mm (13.0inches)
	Width	171mm (6.73inches)
	Container Height	215.5mm (8.48inches)
	Total Height (with Terminal)	235.5mm (9.27inches)
Approx Weight	25.7kg (56.7lbs)	
Terminal	5	
Cell layout	1	
Hold-Down	B0	
Case	Black-PP Material	
Cover	Black-PP Material	
Handle	TS9	

APPLICATIONS

- Car start
- EV/HEV
- Engine start

GENERAL FEATURES

- High capacity and high CCA
- Long life
- Advanced lead-calcium alloy technology, maintenance-free design
- Patented venting system bring less water loss and prevent acid leakage
- OE quality certification

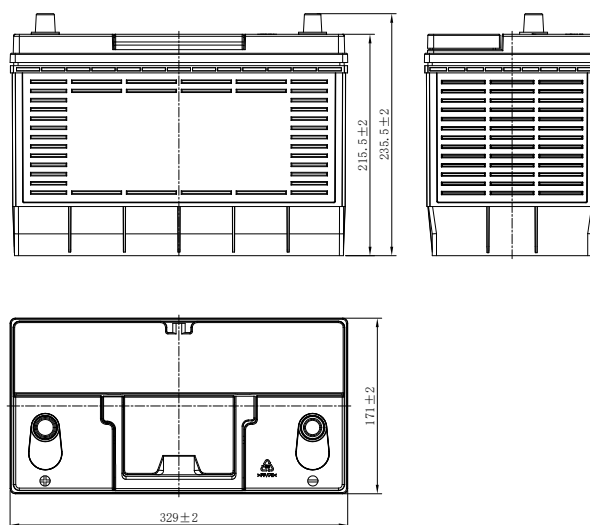
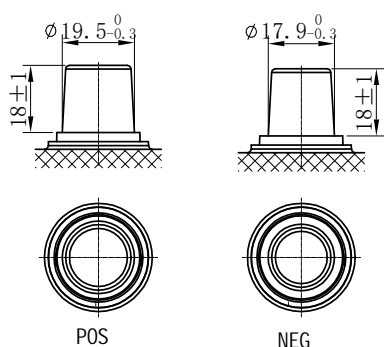

*Values are subject to variation of +/- 5% in normal manufacturing processes.

Leoch International Technology Ltd.
www.leoch.com

Leoch Batteries Pte Ltd
www.leoch.sg

Leoch Battery Corporation
www.leochamericas.com

Leoch Europe S.A.
www.leoch.eu