



LEOCH BATTERY

# BCI 85-480 (12V55Ah)



## Physical Specification (mm)

Nominal Voltage		12V
Nominal Capacity(20HR)		55Ah
Dimension	Length	229±2mm(9.02inches)
	Width	171±2mm(6.73inches)
	Container Height	183±2mm(7.20inches)
	Total Height(with Terminal)	205±2mm(8.07inches)
Weight		Approx 14.0Kg(30.9lbs)
Acid		1.280±0.015g/cm <sup>3</sup> (25°C)
Standard Terminal		1
Cell layout		0
Hold-Down		B01
Cell plate qty		/
Case		Black-PP Material
Cover		Black-PP Material
Handle		Black-PP Material
QTY/PLT/layer		/

## Standard Terminal (mm)      Cell Layout

Terminal Type	D	
	Positive	Negative
1	19.5 <sup>0</sup> <sub>-0.3</sub>	17.9 <sup>0</sup> <sub>-0.3</sub>

Figure(0)

\*Values are subject to variation of +/- 5% in normal manufacturing processes.  
 \*Technical specifications and the product line above could be changed without prior notice.

## Dimensions (mm)

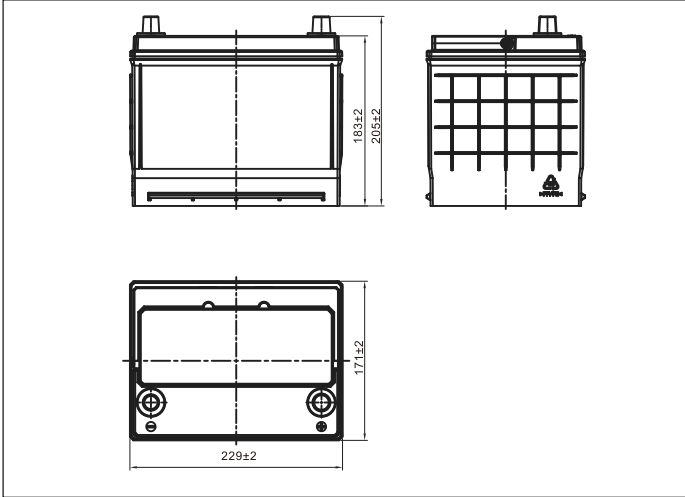

## Electrical Specification

Rated Capacity	20 hour rate(2.75A)	55Ah
Reserve Capacity		88min
Cold Cranking Performance Amps@0°F(-18°C)		480A

## Discharge Characteristics(25°C,70°F)

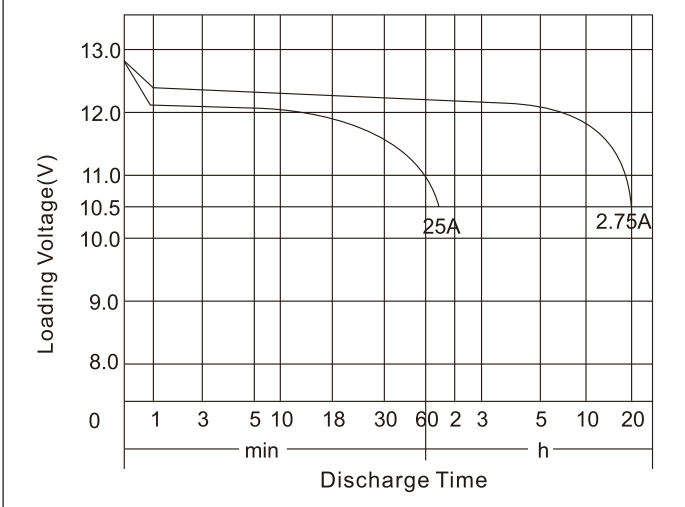

## Discharge Characteristics(-18°C,0°F)

