



LEOCH BATTERY

6-QW-54(440)-L (12V54Ah)



Physical Specification (mm)

Nominal Voltage		12V
Nominal Capacity(20HR)		54Ah
Dimension	Length	314±2mm(12.36inches)
	Width	174±2mm(6.85inches)
	Container Height	190±2mm(7.48inches)
	Total Height(with Terminal)	190±2mm(7.48inches)
Weight		Approx 16.8Kg(37.1lbs)
Acid		1.280±0.015g/cm ³ (25°C)
Standard Terminal		1
Cell layout		0
Hold-Down		B13
Cell plate qty		/
Case		Black-PP Material
Cover		Black-PP Material
Handle		Black-PP Material
QTY/PLT/layer		/

Standard Terminal (mm) Cell Layout

Terminal Type	D	
	Positive	Negative
1	19.5 ⁰ _{-0.3}	17.9 ⁰ _{-0.3}

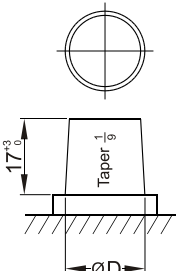
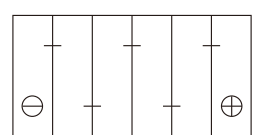
Figure(0)

*Values are subject to variation of +/- 5% in normal manufacturing processes.
*Technical specifications and the product line above could be changed without prior notice.

Dimensions (mm)

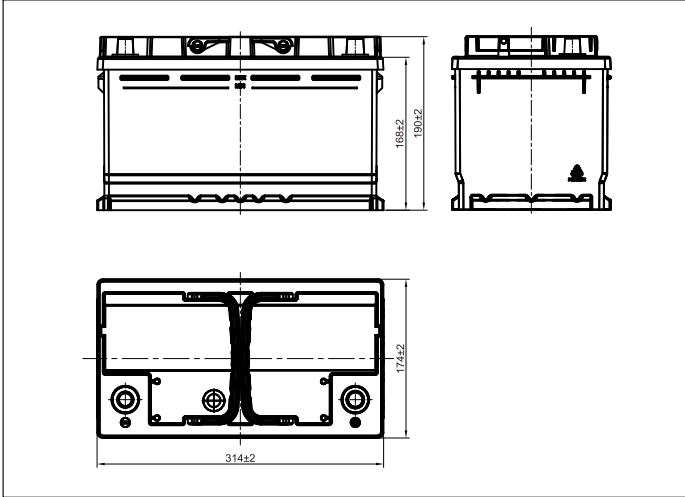

Electrical Specification

Rated Capacity	20 hour rate(2.7A)	54Ah
Reserve Capacity		87min
Cold Cranking Performance Amps@0°F(-18°C)		440A

Discharge Characteristics(25°C,70°F)

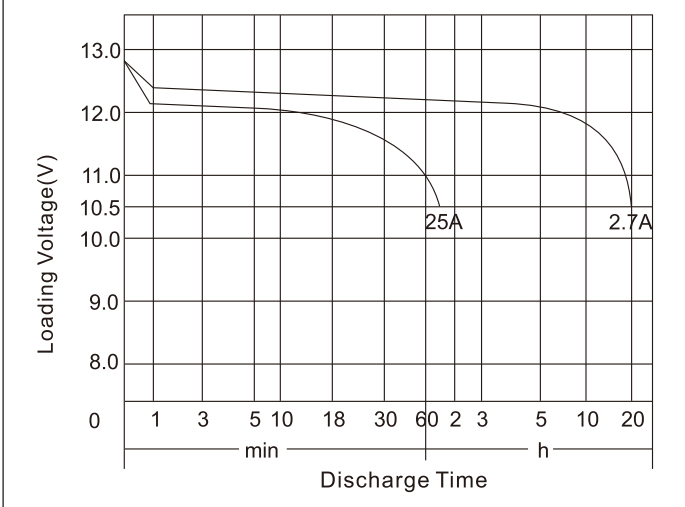

Discharge Characteristics(-18°C,0°F)

