

# FLOODED HIGH TEMPERATURE BATTERY

56545HT (12V65Ah)



## CHARACTERISTICS

| Item                           | Specifications               |                    |
|--------------------------------|------------------------------|--------------------|
| Nominal Voltage                | 12V                          |                    |
| Nominal Capacity (20HR)        | 65Ah                         |                    |
| Reserve Capacity               | 108min                       |                    |
| Cold Cranking Amps@0°F (-18°C) | 480A                         |                    |
| Dimension                      | Length                       | 278mm (10.9inches) |
|                                | Width                        | 175mm (6.89inches) |
|                                | Container Height             | 190mm (7.48inches) |
|                                | Total Height (with Terminal) | 190mm (7.48inches) |
| Approx Weight                  | 16.4kg (36.2lbs)             |                    |
| Terminal                       | 1                            |                    |
| Cell layout                    | 0                            |                    |
| Hold-Down                      | B13                          |                    |
| Case                           | Black-PP Material            |                    |
| Cover                          | Black-PP Material            |                    |
| Handle                         | TS6                          |                    |

## APPLICATIONS

- Car start
- EV/HEV
- Engine start

## GENERAL FEATURES

- Design for high temperature countries and regions
- Superior life in high temperature environment
- High tin alloy and thicker positive grid
- High-temp paste
- Patented venting system bring less water loss and prevent acid leakage

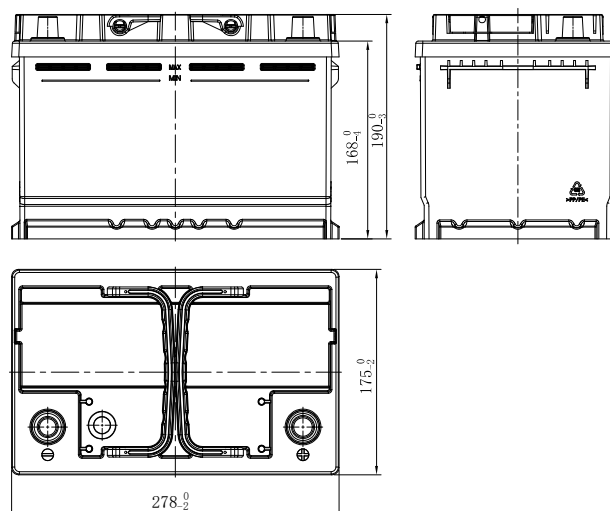
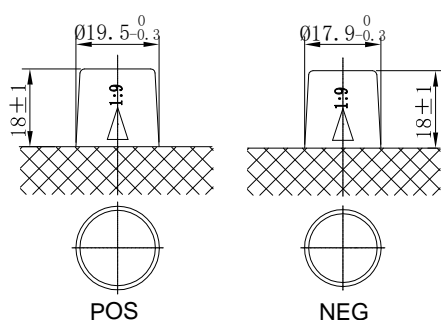

\*Values are subject to variation of +/- 5% in normal manufacturing processes.

Leoch International Technology Ltd.  
[www.leoch.com](http://www.leoch.com)

Leoch Batteries Pte Ltd  
[www.leoch.sg](http://www.leoch.sg)

Leoch Battery Corporation  
[www.leochamericas.com](http://www.leochamericas.com)

Leoch Europe S.A.  
[www.leoch.eu](http://www.leoch.eu)