

FLOODED HIGH TEMPERATURE BATTERY

57543HT (12V75Ah)



CHARACTERISTICS

Item	Specifications	
Nominal Voltage	12V	
Nominal Capacity (20HR)	75Ah	
Reserve Capacity	128min	
Cold Cranking Amps@0°F (-18°C)	540A	
Dimension	Length	314mm (12.4inches)
	Width	174mm (6.85inches)
	Container Height	190mm (7.48inches)
	Total Height (with Terminal)	190mm (7.48inches)
Approx Weight	19.2kg (42.3lbs)	
Terminal	1	
Cell layout	0	
Hold-Down	B13	
Case	Black-PP Material	
Cover	Black-PP Material	
Handle	TS6	

APPLICATIONS

- Car start
- EV/HEV
- Engine start

GENERAL FEATURES

- Design for high temperature countries and regions
- Superior life in high temperature environment
- High tin alloy and thicker positive grid
- High-temp paste
- Patented venting system bring less water loss and prevent acid leakage

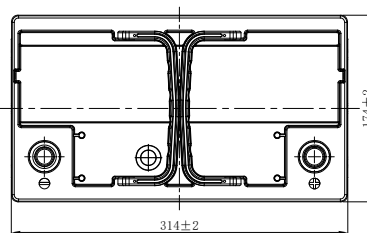
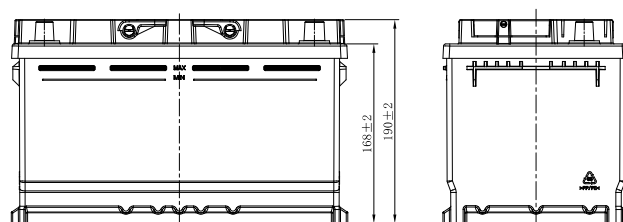
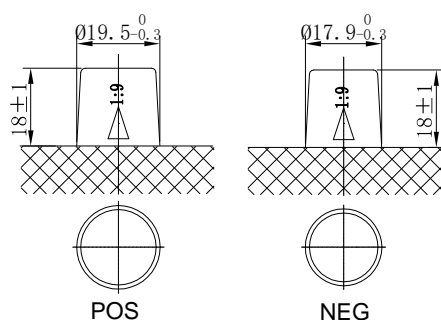

*Values are subject to variation of +/- 5% in normal manufacturing processes.

Leoch International Technology Ltd.
www.leoch.com

Leoch Batteries Pte Ltd
www.leoch.sg

Leoch Battery Corporation
www.leochamericas.com

Leoch Europe S.A.
www.leoch.eu