

FLOODED BATTERY

40B24R (12V40Ah)



CHARACTERISTICS

Item	Specifications	
Nominal Voltage	12V	
Nominal Capacity (20HR)	40Ah	
Reserve Capacity	61min	
Cold Cranking Amps@0°F (-18°C)	350A	
Dimension	Length	236mm (9.29inches)
	Width	128mm (5.04inches)
	Height	222mm (8.74inches)
Approx Weight	11.2kg (24.7lbs)	
Terminal	3	
Cell layout	1	
Hold-Down	B0	
Case	Black-PP Material	
Cover	Black-PP Material	
Handle	TS1	

APPLICATIONS

- Car start
- EV/HEV
- Engine start

GENERAL FEATURES

- High capacity and high CCA
- Long life
- Advanced lead-calcium alloy technology, maintenance-free design
- Patented venting system bring less water loss and prevent acid leakage
- OE quality certification

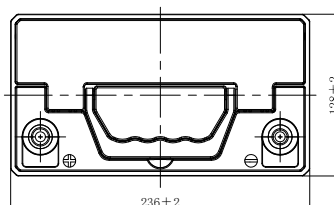
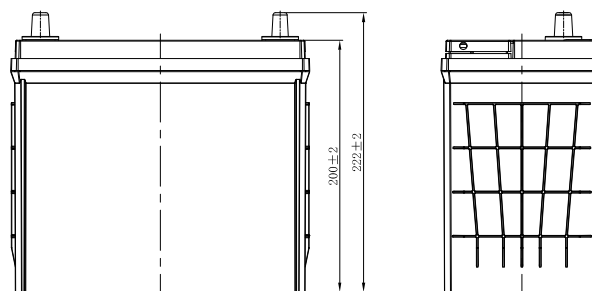
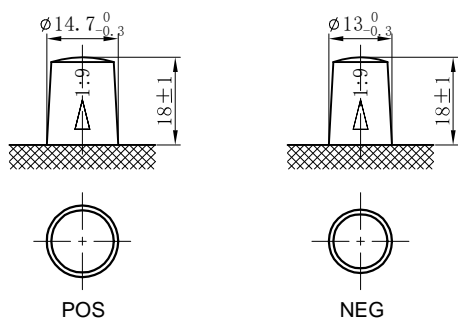

*Values are subject to variation of +/- 5% in normal manufacturing processes.

Leoch International Technology Ltd.
www.leoch.com

Leoch Batteries Pte Ltd
www.leoch.sg

Leoch Battery Corporation
www.leochamericas.com

Leoch Europe S.A.
www.leoch.eu