

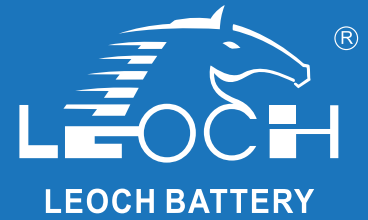

TC Series

TC12-120(12V120Ah)



Specifications

Rated Voltage	12V	
Nominal Capacity	120Ah	(C ₂₀ , 1.80V/cell)
Dimension	Length	330±2mm (13.0 inches)
	Width	173±2mm (6.81 inches)
	Container Height	212±2mm (8.35 inches)
	Total Height	220±2mm (8.66 inches)
Approx Weight	34.2 Kg (75.4lbs)	
Terminal	T11	
Container Material	ABS	
Rated Capacity (25°C)	120.0 Ah	(20hr, 6.00A, 1.80V/cell)
	108.0 Ah	(10hr, 10.8A, 1.80V/cell)
	97.5 Ah	(5hr, 19.5A, 1.75V/cell)
	87.6Ah	(3hr, 29.2A, 1.75V/cell)
	70.5Ah	(1hr, 70.5A, 1.60V/cell)
Max. Discharge Current	1080A (5s)	
Internal Resistance (25°C)	Approx 4.20mΩ	
Operating Temp. Range	Discharge : -20 ~ 55°C (-4 ~ 131°F)	
	Charge : 0 ~ 40°C (32 ~ 104°F)	
	Storage : -20 ~ 50°C (-4 ~ 122°F)	
Nominal Operating Temp. Range	25±3°C (77±5°F)	
Cycle Use	Initial Charging Current less than 27.0A. Voltage 14.4V~14.8V at 25°C(77°F)Temp. Coefficient -30mV/°C	
Standby Use	Initial Charging Current less than 27.0A. Voltage 13.5V~13.8V at 25°C(77°F)Temp. Coefficient -20mV/°C	
Effect of temp. to Capacity	40°C (104°F)	103%
	25°C (77°F)	100%
	0°C (32°F)	86%
Self Discharge	TC series batteries may be stored for up to 6 months at 25°C(77°F) and then a freshening charge is required. For higher temperatures the time interval will be shorter.	



Layout

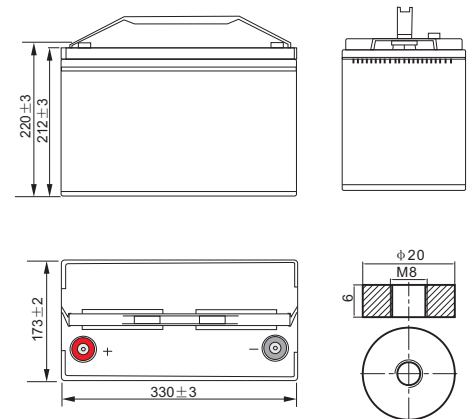

Constant Current Discharge (Amperes) at 25 °C (77°F)

F.V/Time	1h	2h	3h	4h	5h	6h	8h	10h	20h
1.85V/cell	54.0	33.6	25.4	20.5	18.0	15.6	12.5	10.6	5.70
1.80V/cell	59.4	36.9	27.9	22.3	19.1	16.5	13.0	10.8	6.00
1.75V/cell	66.2	40.5	29.2	22.8	19.5	17.0	13.2	11.1	6.08
1.67V/cell	68.6	41.9	29.8	23.4	19.8	17.3	13.5	11.3	6.14
1.60V/cell	70.5	42.8	30.1	23.8	20.0	17.6	13.6	11.4	6.18

Constant Power Discharge (Watts/cell) at 25 °C (77°F)

F.V/Time	1h	2h	3h	4h	5h	6h	8h	10h	20h
1.85V/cell	105.0	65.7	49.8	40.3	35.5	30.7	24.7	20.9	11.3
1.80V/cell	114.7	71.7	54.5	43.6	37.4	32.4	25.7	21.3	11.9
1.75V/cell	126.9	78.3	56.7	44.5	38.2	33.4	26.1	21.9	12.1
1.65V/cell	129.9	80.2	57.5	45.3	38.5	33.7	26.4	22.2	12.2
1.60V/cell	132.4	81.4	57.7	45.8	38.7	34.1	26.5	22.4	12.2



TC Series

TC12-120(12V120Ah)

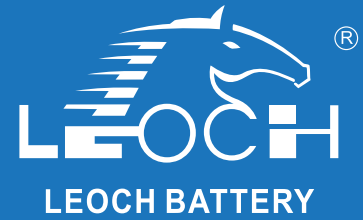

Applications

- Caravan/RV
- Marine

General Features

- Special plate design, long cycle life
≥550 Cycles @ 60% DOD
- Operation temperature -20~55°C
- ≤3% Self discharge per month
- Excellent deep discharge resilience performance

Standards

- Manufactured in Leoch® IATF16949, ISO 9001, ISO 14001 and ISO 45001 certified production facilities

Discharge Characteristics

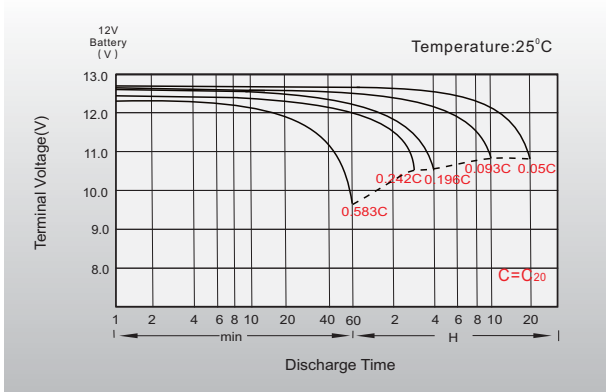

Charging Characteristics

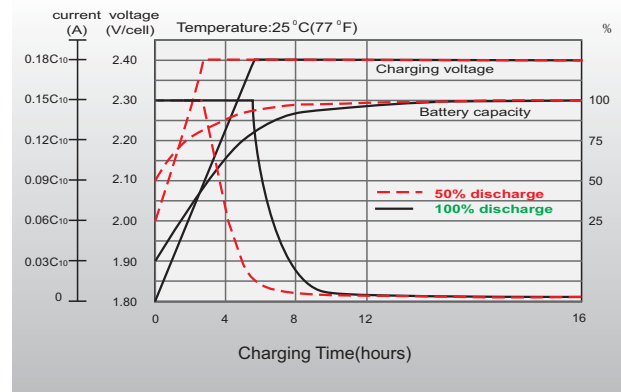

Cycle Life in Relation to Depth of Discharge

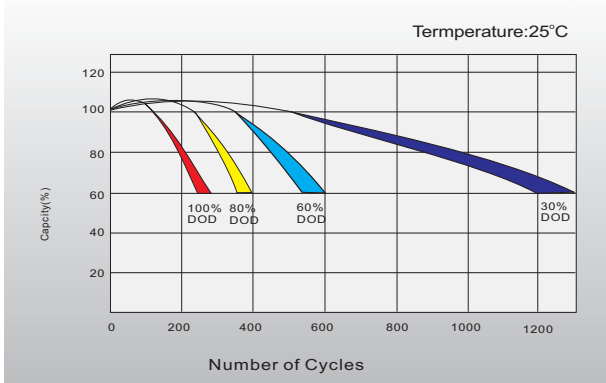

Temperature Effects in Relation to Battery Capacity

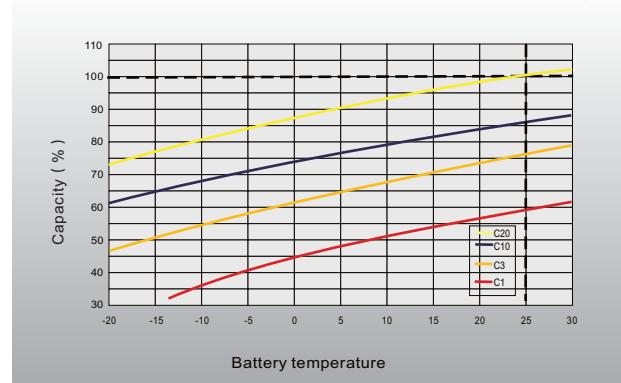

Sales Offices Worldwide

China Sales Office

5th Floor, Xinbaohui Bldg., Nanhai Blvd.,
Nanshan, Shenzhen, China. 518052
Tel: +86-755-86036060 (100 lines)
Fax: +86-755-26067269
E-mail: export@leoch.com

HongKong Sales Office

Workshop C, 33/F, TML Tower, No. 3 Hoi Shing Road,
Tsuen Wan, New Territories, Hong Kong
Tel: +852 35786666
Fax: +44 1452 690125
E-mail: sales.hk@leoch.com

Singapore Sales Office

No. 1 Tech Park Crescent,
Singapore 638131
Tel: +65 68636078
Fax: +65 6863 6079
Email: sales.sg@leoch.com

Australia Sales Office

2 /29 Tarlington Place, Smithfield. NSW 2164
Australia
Tel: 02 9756 0950
E-mail: sales.au@leoch.com

North America Sales Office

19751 Descartes
Foothill Ranch, CA 92610, USA
Tel: 949-588-5853
Fax: 949-588-5966
E-mail: sales@leoch.us

UK Sales Office

Unit B5, Welland Business Park,
Market Harborough Leicestershire,
LE16 7PS UNITED KINGDOM
Tel.: (+44) (0) 1858 433330
E-mail: Sales.Europe@leoch.com

EMEA Sales Office

1 Deligiorgi St., 121 31 Athens,
Greece
Tel: +30 210 5760318 (2 lines)
E-mail: support_EMEA@leoch.com

India Sales Office

Shed no.A-53(b), 2nd Stage of Peenya Industrial Area,
Bangalore North Taluk, Bangalore-560058, India
Tel: +91-80-23440018/23440019
Fax: +91-80-23440017
E-mail: indiasales@leoch.com



[Http://www.leoch.com](http://www.leoch.com)
[Http://www.leoch.us](http://www.leoch.us)

© 2020 LEOCH. All rights reserved.

Trademarks and logos are the property of LEOCH and its affiliates unless otherwise noted.
Subject to revisions without prior notice.

Publication No.:LB-TC12-120-PD-EN-V1.3-2020.08