

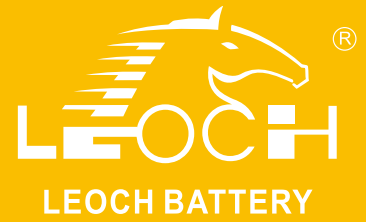

# LPL Series-Long Life Standby LPL2-250(2V250Ah)



## Specifications

Rated Voltage	2V	
Nominal Capacity	250.0Ah	(C <sub>10</sub> , 1.80V/cell)
Dimension	Length	170±2mm (6.69 inches)
	Width	110±2mm (4.33 inches)
	Container Height	328±3mm (12.91 inches)
	Total Height	350±3mm (13.78 inches)
Approx Weight	14.5 Kg (32.0 lbs)	
Terminal	M8	
Container Material	ABS or PP	
Rated Capacity (25°C)	266.0 Ah	(20hr, 13.3A, 1.80V/cell)
	250.0 Ah	(10hr, 25.0A, 1.80V/cell)
	222.0 Ah	(5hr, 44.4A, 1.75V/cell)
	192.9 Ah	(3hr, 64.3A, 1.75V/cell)
	150.2 Ah	(1hr, 150.2A, 1.60V/cell)
Max. Discharge Current	2000A (5s)	
Internal Resistance (25°C)	Approx 1.0mΩ	
Operating Temp. Range	Discharge	-15 ~ 50°C (5 ~ 122°F)
	Charge	0 ~ 40°C (32 ~ 104°F)
	Storage	-15 ~ 40°C (5 ~ 104°F)
Nominal Operating Temp. Range	25±3°C (77±5°F)	
Cycle Use	Initial Charging Current less than 75.0A. Voltage 2.4V~2.5V at 25°C(77°F)Temp. Coefficient -5mV/°C	
	Initial Charging Current less than 75.0A. Voltage 2.25V~2.30V at 25°C(77°F)Temp. Coefficient -3mV/°C	
Effect of temp. to Capacity	40°C (104°F)	103%
	25°C (77°F)	100%
	0°C (32°F)	86%
Self Discharge	LPL series batteries may be stored for up to 6 months at 25°C(77°F) and then a freshening charge is required. For higher temperatures the time interval will be shorter.	



## Layout

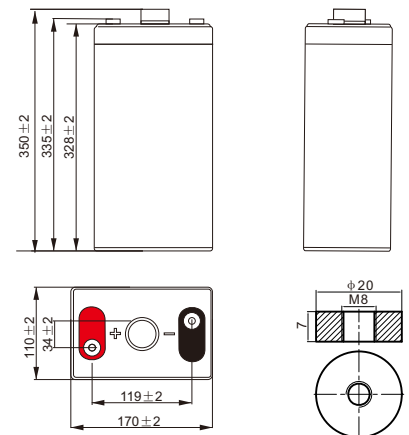

## Constant Current Discharge (Amperes) at 25 °C (77°F)

F.V/Time	15min	20min	30min	45min	1h	2h	3h	4h	5h	6h	8h	10h	20h
1.85V/cell	251.5	226.5	187.6	150.4	125.4	77.8	59.3	48.5	41.3	36.1	28.9	24.1	12.9
1.80V/cell	285.8	252.3	201.3	158.2	131.1	81.3	62.3	50.7	43.0	37.7	30.1	25.0	13.3
1.75V/cell	314.0	271.9	213.1	166.4	136.8	84.5	64.3	52.4	44.4	38.6	30.7	25.3	13.4
1.70V/cell	335.3	290.9	223.6	172.6	141.6	87.9	66.3	53.6	45.1	39.3	31.3	25.6	13.6
1.65V/cell	353.3	305.3	234.6	180.2	146.7	90.8	67.8	54.7	46.1	40.0	31.7	25.9	13.7
1.60V/cell	370.3	316.5	242.6	185.0	150.2	92.5	69.0	55.5	46.8	40.5	32.2	26.3	13.8

## Constant Power Discharge (Watts/cell) at 25 °C (77°F)

F.V/Time	15min	20min	30min	45min	1h	2h	3h	4h	5h	6h	8h	10h	20h
1.85V/cell	476.2	430.8	358.5	289.2	242.6	151.2	116.0	95.2	81.4	71.3	57.3	47.9	25.6
1.80V/cell	534.2	474.8	381.6	302.2	252.2	157.3	121.1	99.1	84.4	74.2	59.6	49.6	26.5
1.75V/cell	578.7	505.9	401.0	315.9	262.0	162.9	124.8	102.1	86.7	75.7	60.6	50.2	26.6
1.70V/cell	611.4	536.7	417.2	325.5	269.8	168.7	128.2	103.9	88.0	76.9	61.6	50.8	26.9
1.65V/cell	636.3	557.0	434.4	337.8	277.9	173.5	130.5	105.8	89.5	78.0	62.4	51.3	27.1
1.60V/cell	655.9	571.0	444.8	343.7	282.5	175.8	132.1	106.8	90.5	78.9	63.2	52.0	27.3



# LPL Series-Long Life Standby LPL2-250(2V250Ah)

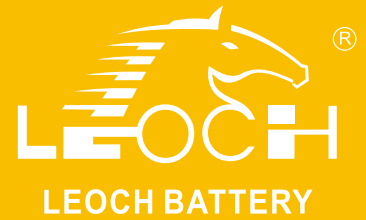

## Applications

- Tele-communication central station (wired or cellular)
- Power system communication, military communication, etc.
- Network communication including: data transmission, television signal transmission, etc.
- Uninterruptable Power System (UPS- for Telecom)
- EPS

## General Features

- 20 years design life
- Grid refining technology and the thicker plates are used to extend the battery standby life and reduce the plate grid corrosion speed
- Using oxygen recombination technology: maintenance-free
- Unique vent valve design: control water losing, prevent air and spark going inside
- Can be operated in upright, side, or end mounting orientation

## Standards

- Compliance with IEC 60896 standards, EU Battery Directive
- UL, CE Certified
- Manufactured in Leoch@IATF16949, OHSAS 18001, ISO 9001 and ISO 14001 certified production facilities

## Discharge Characteristics

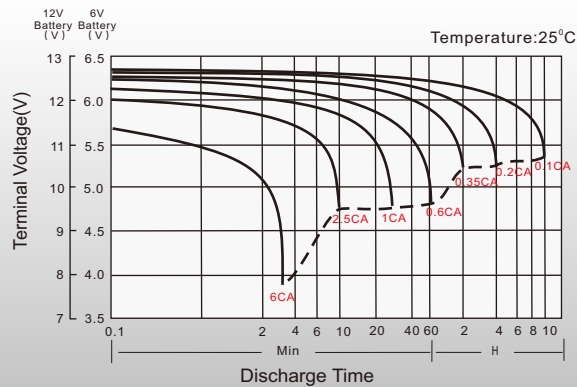

## Float Charging Characteristics

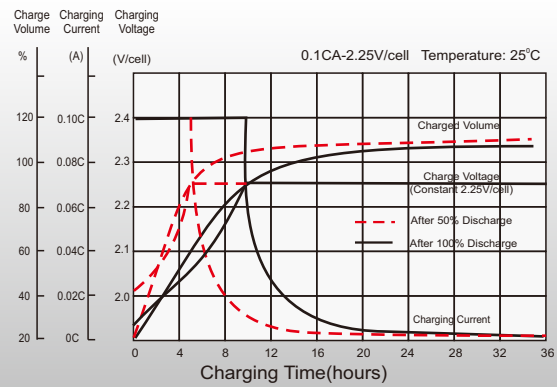

## Temperature Effects in Relation to Battery Capacity

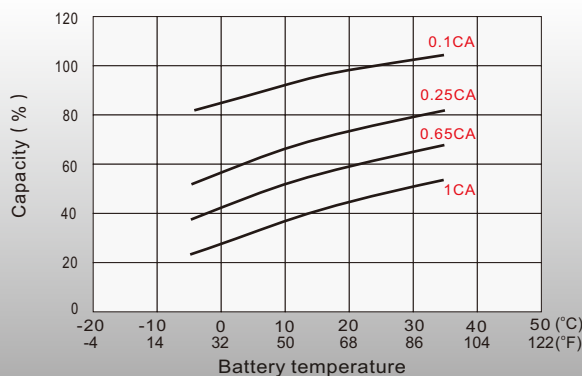

## Design Life

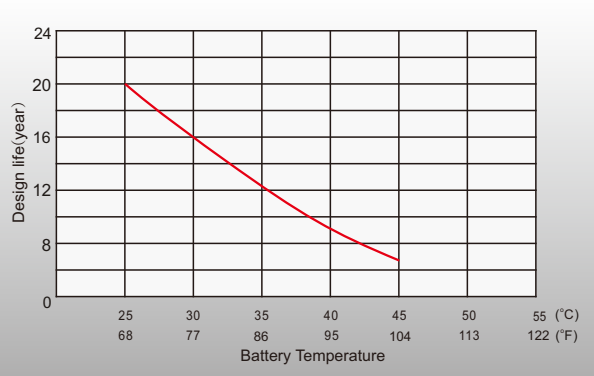

## Sales Offices Worldwide

### China Sales Office

5th Floor, Xinbaohui Bldg., Nanhai Blvd.,  
Nanshan, Shenzhen, China. 518052  
Tel: +86-755-86036060 (100 lines)  
Fax: +86-755-26067269  
E-mail: export@leoch.com

### HongKong Sales Office

Workshop C, 33/F, TML Tower, No. 3 Hoi Shing Road,  
Tsuen Wan, New Territories, Hong Kong  
Tel: +852 35786666  
Fax: +44 1452 690125  
E-mail: sales.hk@leoch.com

### Singapore Sales Office

No. 1 Tech Park Crescent,  
Singapore 638131  
Tel: +65 68636078  
Fax: +65 6863 6079  
Email: sales.sg@Leoch.com

### Australia Sales Office

2 /29 Tarlington Place, Smithfield. NSW 2164  
Australia  
Tel: 02 9756 0950  
E-mail: sales.au@leoch.com

### North America Sales Office

19751 Descartes  
Foothill Ranch, CA 92610, USA  
Tel: 949-588-5853  
Fax: 949-588-5966  
E-mail: sales@leoch.us

### UK Sales Office

9B Wheatstone Court. Waterwells, Business Park,  
Gloucester, GL2-2AQ, UK United Kingdom  
Tel: +44(0) 1452 729428 / 1452 729696  
Fax: +44 1452 690125  
E-mail: Sales.Europe@leoch.com

### EMEA Sales Office

1 Deligiorgi St., 121 31 Athens,  
Greece  
Tel: +30 210 5760318 (2 lines)  
E-mail: support\_EMEA@leoch.com

### India Sales Office

Shed no.A-53(b), 2nd Stage of Peenya Industrial Area,  
Bangalore North Taluk, Bangalore-560058, India  
Tel: +91-80-23440018/23440019  
Fax: +91-80-23440017  
E-mail: indiasales@leoch.com



[Http://www.leoch.com](http://www.leoch.com)

[Http://www.leoch.us](http://www.leoch.us)

© 2019 LEOCH. All rights reserved.

Trademarks and logos are the property of LEOCH and its affiliates unless otherwise noted.

Subject to revisions without prior notice.

Publication No.: LP-LPL2-250-SGTHSE-V2.1-201909