

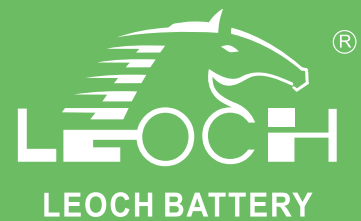

LPGS Series-Gel Battery

LPGS12-250(12V250Ah)



Specifications

Rated Voltage	12V	
Nominal Capacity	250Ah (C ₂₀ , 1.75V/cell)	
Dimension	Length	522±3mm (20.6 inches)
	Width	268±3mm (10.6 inches)
	Container Height	220±3mm (8.66 inches)
	Total Height	226±3mm (8.90 inches)
Approx Weight	75.5 Kg (166.4 lbs)	
Terminal	M8	
Container Material	ABS	
Rated Capacity (25°C)	269.0 Ah	(100hr, 2.69A, 1.80V/cell)
	265.7 Ah	(72hr, 3.69A, 1.80V/cell)
	250.0 Ah	(20hr, 12.5A, 1.75V/cell)
	228.0 Ah	(10hr, 22.8A, 1.80V/cell)
	150.3 Ah	(1hr, 150.3A, 1.75V/cell)
Max. Discharge Current	2280A (5s)	
Internal Resistance (25°C)	Approx 2.9mΩ	
Operating Temp. Range	Discharge : -20 ~ 55°C (-4 ~ 131°F)	
	Charge : 0 ~ 40°C (32 ~ 104°F)	
	Storage : -20 ~ 50°C (-4 ~ 122°F)	
Nominal Operating Temp. Range	25±3°C (77±5°F)	
Cycle Use	Initial Charging Current less than 57.0A. Voltage 14.1V~14.4V at 25°C(77°F)Temp. Coefficient -30mV/°C	
	Standby Use	
Effect of temp. to Capacity	Initial Charging Current less than 57.0A. Voltage 13.5V~13.8V at 25°C(77°F)Temp. Coefficient -20mV/°C	
	40°C (104°F)	103%
	25°C (77°F)	100%
Self Discharge	0°C (32°F)	86%
	LPGS series batteries may be stored for up to 6 months at 25°C(77°F) and then a freshening charge is required. For higher temperatures the time interval will be shorter.	

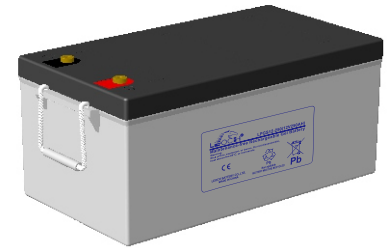

Layout

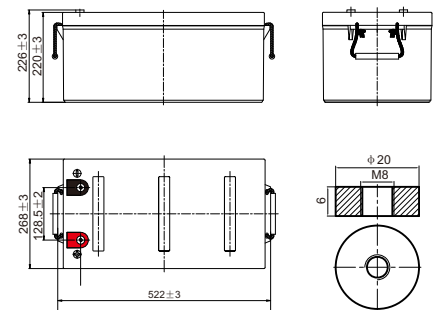

Constant Current Discharge (Amperes) at 25 °C (77°F)

F.V/Time	1h	2h	3h	4h	5h	6h	8h	10h	20h	48h	72h	100h
1.90V/cell	110.6	69.8	53.3	43.6	36.8	31.6	24.6	20.3	10.9	4.84	3.29	2.38
1.85V/cell	132.3	78.1	58.5	47.5	40.0	34.5	26.9	22.1	11.9	5.23	3.56	2.60
1.80V/cell	143.0	82.4	61.3	49.3	41.4	35.5	27.8	22.8	12.2	5.39	3.69	2.69
1.75V/cell	150.3	86.0	63.3	50.8	42.3	36.3	28.3	23.3	12.5	5.48	3.74	2.74

Constant Power Discharge (Watts/cell) at 25 °C (77°F)

F.V/Time	1h	2h	3h	4h	5h	6h	8h	10h	20h	48h	72h	100h
1.90V/cell	216.6	137.5	105.9	86.9	73.8	63.5	49.4	40.5	21.6	9.68	6.56	4.75
1.85V/cell	256.4	152.6	115.1	93.9	79.6	68.5	53.5	44.1	23.8	10.5	7.14	5.23
1.80V/cell	274.5	159.6	120.0	94.4	81.9	70.4	55.1	45.3	24.4	10.8	7.36	5.38
1.75V/cell	287.5	166.0	123.5	99.4	83.3	71.6	55.9	46.0	24.9	11.0	7.48	5.48



LPGS Series-Gel Battery

LPGS12-250(12V250Ah)

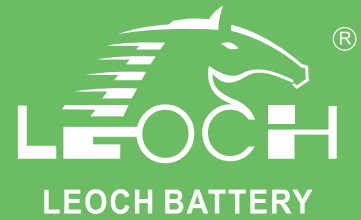

Applications

- Solar energy (wind energy) household system /communication / communication base station;
- Movable energy storage system;
- Solar traffic lights;
- Solar, wind and solar power generation;
- Emergency lighting system.

General Features

- Adopted advantage AGM-GEL technology
- Operation temperature -20~55°C
- ≤3% Self discharge per month
- Fast recharge

Standards

- IEC 60896 Certified
- Classified as "Long Life" according to Eurobat
- Manufactured in Leoch® IATF16949, ISO 9001, ISO 14001 and ISO 45001 certified production facilities

Temperature Effects in Relation to Battery Capacity

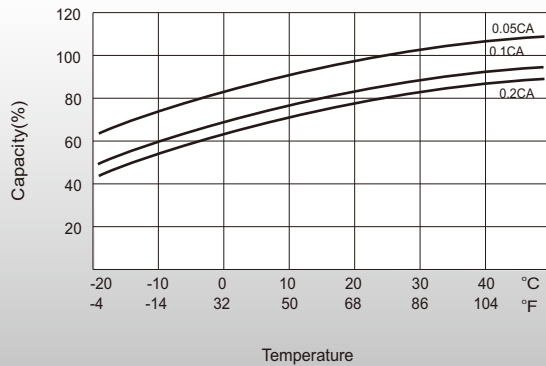

Charging Characteristics

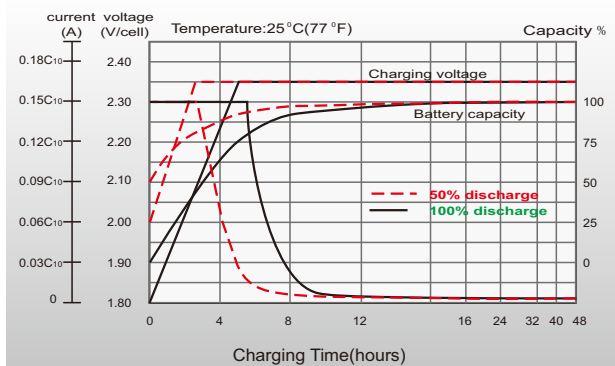

Cycle Life in Relation to Depth of Discharge

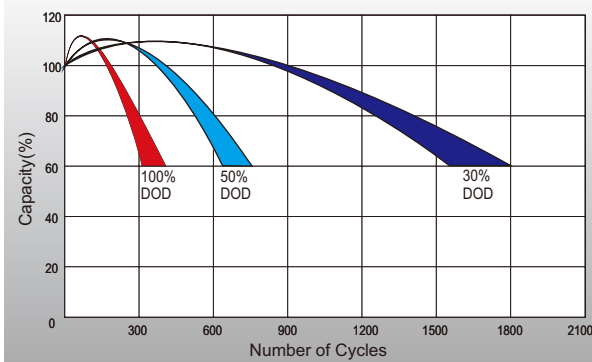

Self Discharge Characteristics

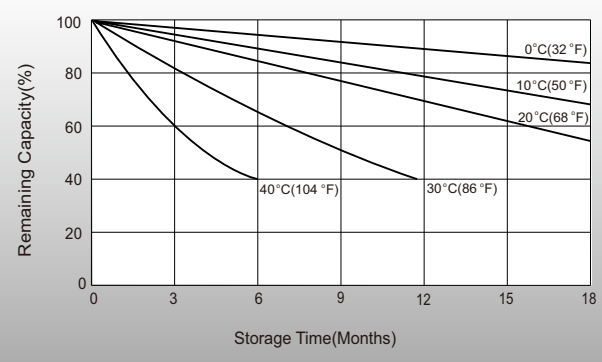

Sales Offices Worldwide

China Sales Office

5th Floor, Xinbaohui Bldg., Nanhai Blvd.,
Nanshan, Shenzhen, China. 518052
Tel: +86-755-86036060 (100 lines)
Fax: +86-755-26067269
E-mail: export@leoch.com

HongKong Sales Office

Workshop C, 33/F, TML Tower, No. 3 Hoi Shing Road,
Tsuen Wan, New Territories, Hong Kong
Tel: +852 35786666
Fax: +44 1452 690125
E-mail: sales.hk@leoch.com

Singapore Sales Office

No. 1 Tech Park Crescent,
Singapore 638131
Tel: +65 68636078
Fax: +65 6863 6079
Email: sales.sg@Leoch.com

Australia Sales Office

2/29 Tarlington Place, Smithfield. NSW 2164
Australia
Tel: 02 9756 0950
E-mail: sales.au@leoch.com

North America Sales Office

19751 Descartes
Foothill Ranch, CA 92610, USA
Tel: 949-588-5853
Fax: 949-588-5966
E-mail: sales@leoch.us
Http://www.leoch.us

UK Sales Office

9B Wheatstone Court, Waterwells, Business Park,
Gloucester, GL2-2AQ, UK United Kingdom
Tel: +44(0) 1452 729428 / 1452 729696
Fax: +44 1452 690125
E-mail: Sales.Europe@leoch.com
Http://www.leoch.eu

EMEA Sales Office

1 Deligiorgi St., 121 31 Athens,
Greece
Tel: +30 210 5760318 (2 lines)
E-mail: support_EMEA@leoch.com
Http://www.leoch.eu

India Sales Office

Shed no. A-53(b), 2nd Stage of Peenya Industrial Area,
Bangalore North Taluk, Bangalore-560058, India
Tel: +91-80-23440018/23440019
Fax: +91-80-23440017
E-mail: indiasales@leoch.com



[Http://www.leoch.com](http://www.leoch.com)

© 2019 LEOCH. All rights reserved.

Trademarks and logos are the property of LEOCH and its affiliates unless otherwise noted.
Subject to revisions without prior notice.

Publication No.: LB-LPGS12-250-PD-EN-V2.2-202004