

LHR SERIES-HIGH RATE

LHR12430W (12V430W)

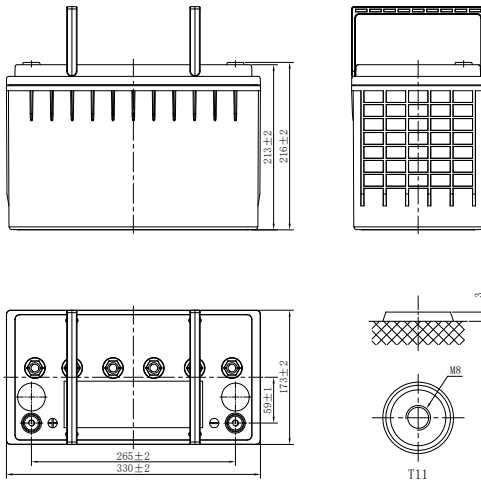

CHARACTERISTICS

Item	Specifications	
Rated Voltage	12V	
Nominal Rate (25°C)	$W_{15}, 1.67V/cell$	430W/cell
Nominal Capacity (25°C)	$C_{10}, 1.80V/cell$	100Ah
Dimension	Length	330mm (13.0inches)
	Width	173mm (6.81inches)
	Container Height	213mm (8.39inches)
	Total Height	216mm (8.50inches)
Approx Weight	32.0kg (70.5lbs)	
Terminal	T11(M8)	
Container Material	ABS (UL94 HB or V-0 optional)	
Short-circuit current	2500A	
Internal Resistance (25°C)	Approx 3.5 mΩ (Fully charged)	
Operating Temp. Range	Discharge	-20~55°C (-4~131°F)
	Charge	-20~40°C (-4~104°F)
	Storage	-15~50°C (5~122°F)
Nominal Operating Temp. Range	25±3°C (77±5°F)	
Max.Charging Current (25°C)	0.25C	
Charge voltage (25°C)	Float Charge	Equalization Charge
	2.25-2.30V/cell	2.30-2.40V/cell
Temp. Coefficient	-3mV/cell/°C	-4mV/cell/°C
	40°C (104°F)	106%
Effect of temp. to Capacity	25°C (77°F)	100%
	0°C (32°F)	86%
	Self Discharge	≤ 3% per month at 25°C (77°F)

DISCHARGE TABLE

Constant Current Discharge (Amperes) at 25°C (77°F)														
F.V/Time	5min	10min	15min	20min	30min	45min	1h	1.5h	2h	3h	4h	5h	8h	10h
1.85V/cell	294.7	231.6	186.2	145.5	102.0	73.1	57.3	40.9	32.6	24.0	19.6	16.7	11.9	9.70
1.80V/cell	335.8	258.8	208.5	163.0	108.3	77.6	60.9	43.2	34.3	25.1	20.4	17.3	12.2	10.0
1.75V/cell	362.9	271.3	218.6	174.3	113.8	80.9	63.5	44.8	35.6	26.1	21.0	17.8	12.3	10.1
1.70V/cell	385.7	281.4	224.1	183.5	118.9	83.5	65.3	46.3	36.7	26.7	21.5	18.2	12.5	10.2
1.67V/cell	397.8	290.8	230.5	189.4	122.9	85.6	67.0	47.3	37.5	27.2	21.8	18.4	12.6	10.3
1.60V/cell	403.8	299.3	238.1	192.9	126.3	87.4	68.4	48.2	38.2	27.9	22.3	18.8	12.7	10.4

Constant Power Discharge (Watts/cell) at 25°C (77°F)														
F.V/Time	5min	10min	15min	20min	30min	45min	1h	1.5h	2h	3h	4h	5h	8h	10h
1.85V/cell	544.7	452.1	359.6	290.0	209.9	148.3	115.6	82.1	65.3	48.3	39.8	34.1	24.1	20.1
1.80V/cell	615.6	503.9	400.8	315.2	225.1	157.0	122.3	86.2	68.1	50.1	41.0	35.1	24.5	20.5
1.75V/cell	663.5	525.8	418.3	336.3	236.7	164.9	128.0	90.2	71.3	51.9	42.2	36.0	24.9	20.6
1.70V/cell	705.1	532.4	423.6	350.8	245.6	171.1	132.3	93.0	73.2	53.4	43.3	36.7	25.2	20.8
1.67V/cell	731.0	540.5	430.0	358.7	251.9	175.6	135.5	95.0	74.7	54.5	44.1	37.1	25.6	21.0
1.60V/cell	741.5	548.7	443.2	362.6	255.2	178.1	137.7	96.7	76.0	55.1	44.6	37.6	25.9	21.2

LHR SERIES-HIGH RATE

LHR12430W (12V430W)



APPLICATIONS

- UPS
- Hospitals and Testing Laboratories
- Emergency Power Supply
- Industrial Process Control Facilities
- Banks and Financial Markets
- Data and Network Operation Centers

GENERAL FEATURES

- 12 years design life (25°C)
- Excellent high current performance - optimised for short discharge time
- Advanced AGM technology for superior high-rate power
- Long Life Alloy - minimizing grid growth, reducing gassing, and extending battery life
- Epoxy-sealed posts eliminate leaks
- Optimal energy density - saves floor space

STANDARDS

- Compliance with IEC 60896 standards
- Classified as "Long Life" according to Eurobat
- CE, UL Approved
- Manufactured in Leoch@IATF 16949, ISO 45001, ISO 9001 and ISO 14001 certified production facilities

Discharge Characteristics

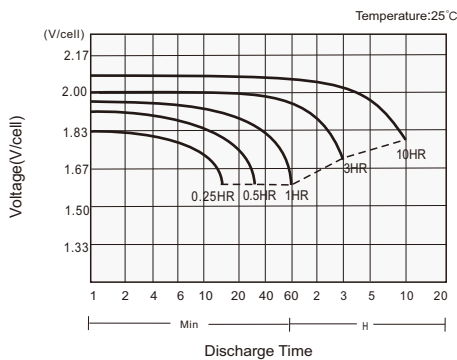

Charging Characteristics

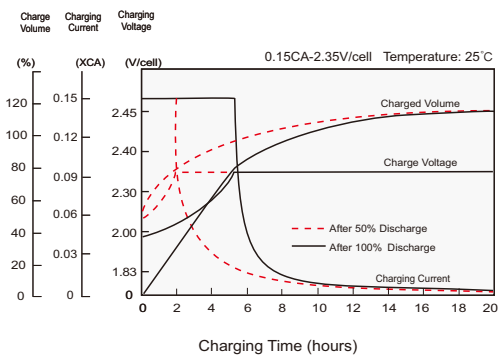

Effects of Temperature on Capacity

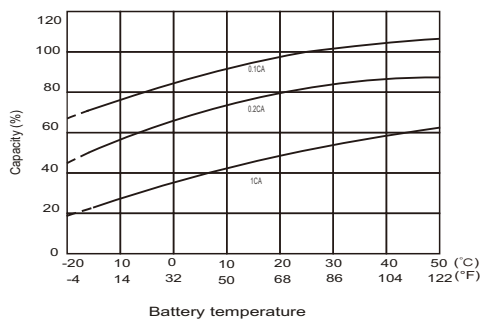

Self Discharge Characteristics

