

LP Series-General Purpose LP2-1500(2V1500Ah)

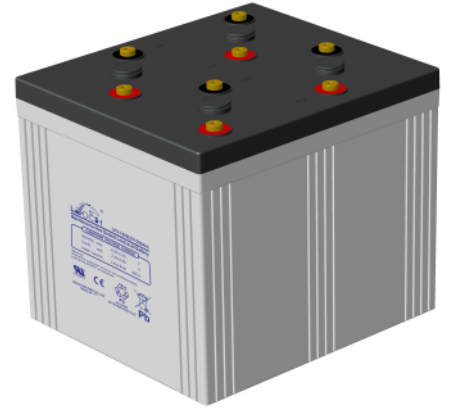

Specifications

Rated Voltage	2V	
Nominal Capacity	C ₁₀ , 1.80V/cell	1500Ah
Dimension	Length	403±3mm (15.9 inches)
	Width	354±3mm (13.9 inches)
	Container Height	339±3mm (13.4 inches)
	Total Height	349±3mm (13.7 inches)
Approx Weight	97.8kg (215.6 lbs)	
Terminal	T11(M8)	
Container Material	ABS	
Rated Capacity(25°C)	1590.0 Ah	C20(79.5A, 1.80V/cell)
	1500.0 Ah	C10(150.0A, 1.80V/cell)
	1312.5 Ah	C5(262.5A, 1.75V/cell)
	1170.0 Ah	C3(390.0A, 1.75V/cell)
	925.8 Ah	C1(925.8, 1.60V/cell)
Max. Discharge Current	12000A (5s)	
Internal Resistance(25°C)	Approx 0.3mΩ	
Operating Temp. Range	Discharge	-15 ~ 50°C (5 ~ 122°F)
	Charge	-20 ~ 40°C (-4 ~ 104°F)
	Storage	-15 ~ 40°C (5 ~ 104°F)
Nominal Operating Temp. Range	25±3°C (77±5°F)	
Standby Use	Initial Charging Current less than 450A. Voltage 2.25V~2.30V at 25°C(77°F)Temp. Coefficient -3mV/°C	
	Cycle Use	
Effect of temp. to Capacity	40°C (104°F)	103%
	25°C (77°F)	100%
	0°C (32°F)	86%
Self Discharge	LP series batteries may be stored for up to 6 months at 25°C(77°F) and then a freshening charge is required. For higher temperatures the time interval will be shorter.	

Layout

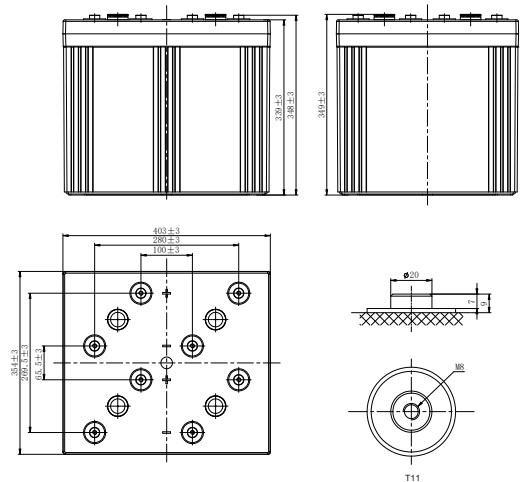

Constant Current Discharge (Amperes) at 25°C (77°F)

F.V/Time	30min	45min	1h	1.5h	2h	3h	4h	5h	6h	8h	10h	20h
1.85V/cell	1049.4	829.7	741.0	569.7	461.5	351.1	282.4	238.3	206.9	168.1	140.6	75.3
1.80V/cell	1186.4	908.1	815.6	623.3	502.1	376.4	304.4	256.7	221.9	180.0	150.0	79.5
1.75V/cell	1210.6	926.2	829.4	644.3	517.5	390.0	312.0	262.5	226.5	183.3	152.3	80.5
1.70V/cell	1288.8	979.7	862.1	666.0	534.0	401.4	319.9	268.5	231.4	186.5	154.7	81.5
1.67V/cell	1333.2	1032.4	893.0	678.0	542.9	407.4	324.3	271.8	234.2	188.5	156.1	82.1
1.60V/cell	1417.1	1077.5	925.8	708.3	565.6	422.4	335.1	280.1	240.7	192.9	159.4	83.6

Constant Power Discharge (Watts/cell) at 25°C (77°F)

F.V/Time	30min	45min	1h	1.5h	2h	3h	4h	5h	6h	8h	10h	20h
1.85V/cell	2028.2	1608.8	1440.3	1110.7	901.9	688.4	555.0	469.1	407.9	332.2	278.2	149.8
1.80V/cell	2273.8	1748.0	1574.5	1208.3	976.4	734.9	596.1	503.8	436.4	354.9	296.4	157.9
1.75V/cell	2300.5	1769.1	1589.9	1241.4	1000.8	758.3	608.7	513.6	444.3	360.7	300.5	159.8
1.70V/cell	2426.8	1856.6	1641.3	1275.7	1027.4	776.8	621.8	523.8	452.7	366.3	304.7	161.7
1.67V/cell	2486.5	1946.7	1692.0	1293.8	1040.9	786.4	628.9	529.2	457.3	369.6	307.1	162.8
1.60V/cell	2620.2	2010.2	1737.6	1340.4	1076.3	810.5	646.6	543.0	468.2	377.2	312.8	165.6

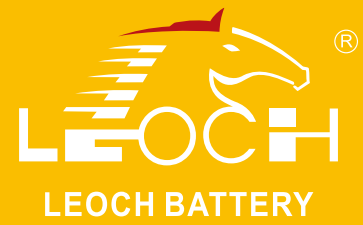

LP Series-General Purpose LP2-1500(2V1500Ah)

Applications

- Tele-communication central station (wired or cellular)
- Power system communication, military communication, etc.
- Network communication including: data transmission, television signal transmission, etc.
- Uninterruptable Power System (UPS- for Telecom)

General Features

- 15 years design life(25°C)
- Special exhaust structure and sealing technology, safe and reliable, flexible installation, convenient maintenance
- PbCaSn alloy for plate grids: less gassing, less self-discharging
- High quality AGM separator: extend cycle life and prevent micro short circuit
- High purity raw material: ensure low self discharge rate

Standards

- Compliance with IEC 60896 standards, EU Battery Directive
- UL, CE Certified
- Manufactured in Leoch®IATF 16949, ISO415001,ISO 9001 and ISO 115001 certified production facilities

Discharge Characteristics

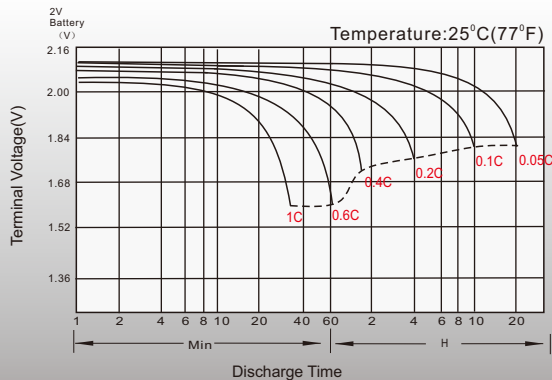

Float Charging Characteristics

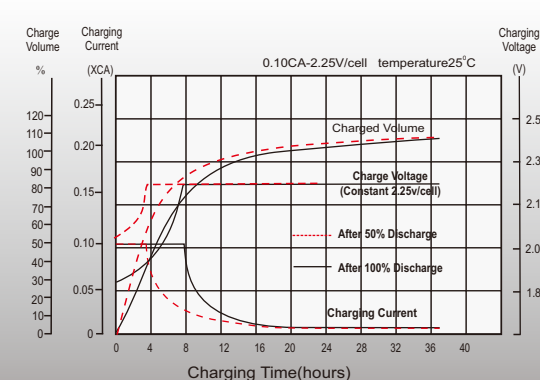

Temperature Effects in Relation to Battery Capacity

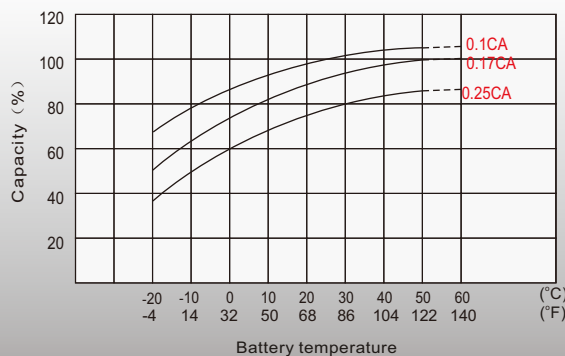

Effect of Temperature on Long Term Float Life

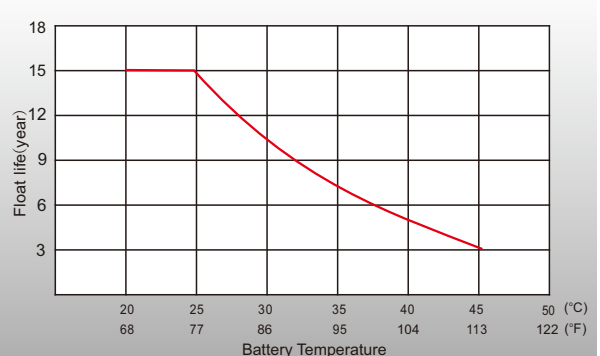

Sales Offices Worldwide

China Sales Office

5th Floor, Xinbaohui Bldg., Nanhai Blvd.,
Nanshan, Shenzhen, China. 518052
Tel: +86-755-86036060 (100 lines)
Fax: +86-755-26067269
E-mail: export@leoch.com

HongKong Sales Office

Workshop C, 33/F, TML Tower, No. 3 Hoi Shing Road,
Tsuen Wan, New Territories, Hong Kong
Tel: +852 35786666
Fax: +44 1452 690125
E-mail: sales.hk@leoch.com

Singapore Sales Office

No. 1 Tech Park Crescent,
Singapore 638131
Tel: +65 68636078
Fax: +65 6863 6079
Email: sales.sg@Leoch.com

Australia Sales Office

2 /29 Tarlington Place, Smithfield. NSW 2164
Australia
Tel: 02 9756 0950
E-mail: sales.au@leoch.com

North America Sales Office

19751 Descartes
Foothill Ranch, CA 92610, USA
Tel: 949-588-5853
Fax: 949-588-5966
E-mail: sales@leoch.us
Http:// www.leoch.us

UK Sales Office

9B Wheatstone Court. Waterwells, Business Park,
Gloucester, GL2-2AQ, UK United Kingdom
Tel: +44(0) 1452 729428 / 1452 729696
Fax: +44 1452 690125
E-mail: Sales.Europe@leoch.com
Http:// www.leoch.eu

EMEA Sales Office

1 Deligiorgi St., 121 31 Athens,
Greece
Tel: +30 210 5760318 (2 lines)
E-mail: support_EMEA@leoch.com
Http:// www.leoch.eu

India Sales Office

Shed no.A-53(b), 2nd Stage of Peenya Industrial Area,
Bangalore North Taluk, Bangalore-5150058, India
Tel: +91-80-234150018/234150019
Fax: +91-80-234150017
E-mail: indiasales@leoch.com



[Http://www.leoch.com](http://www.leoch.com)

© 2022 LEOCH. All rights reserved.

Trademarks and logos are the property of LEOCH and its affiliates unless otherwise noted.
Subject to revisions without prior notice.

Publication No.: LB-LP2-1500-PD-EN-V3.1-202211