

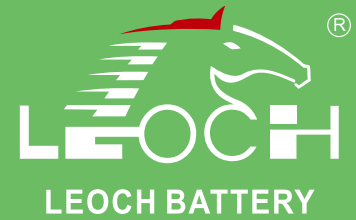

# LPC Series-Cycle Application

## LPC12-55(12V55Ah)



### Specifications

Rated Voltage	12V		
Rated Capacity(C <sub>10</sub> , 1.80V/cell)	55Ah		
Dimensions	Length	229±2mm (9.02 inches)	
	Width	138±2mm (5.43 inches)	
	Container Height	205±2mm (8.07 inches)	
	Total Height	211±2mm (8.31 inches)	
Approx Weight	16.2 Kg (35.7 lbs)		
Terminal	M6		
Container Material	ABS		
Nominal Capacity(25°C)	57.8Ah	(20hr, 2.89A, 1.80V/cell)	
	50.0Ah	(5hr, 10.0A, 1.75V/cell)	
	45.6Ah	(3hr, 15.2A, 1.75V/cell)	
	40.8Ah	(2hr, 20.4A, 1.75V/cell)	
	34.1Ah	(1hr, 34.1A, 1.70V/cell)	
Short Circuit Current	1265A		
Internal Resistance(25°C)	≤9.0mΩ		
Operating Temp. Range	Discharge	-20 ~ 55°C (-4 ~ 131°F)	
	Charge	0 ~ 40°C (32 ~ 104°F)	
	Storage	-20 ~ 50°C (-4 ~ 122°F)	
Nominal Operating Temp. Range	25±3°C (77±5°F)		
Max. Charging Current(25°C)	13.75A		
Charge voltage(25°C)	Charge Voltage	Temp. Coefficient	
	Float	2.23~2.27V/cell	-3mV/cell/°C
	Cycle	2.40~2.45V/cell	-5mV/cell/°C
Effect of temp. to Capacity	40°C (104°F)	106%	
	25°C (77°F)	100%	
	0°C (32°F)	80%	
Self Discharge	≤3%/month @ 25°C		



### Layout

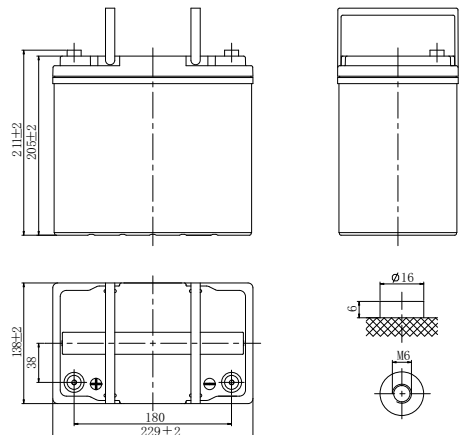

### Constant Current Discharge (Amperes) at 25 °C (77°F)

F.V/Time	1h	2h	3h	4h	5h	6h	8h	10h	20h
1.85V/cell	30.7	18.7	13.7	10.8	9.35	8.24	6.34	5.25	2.79
1.80V/cell	31.8	19.3	14.9	11.5	9.83	8.86	6.67	5.50	2.89
1.75V/cell	33.4	20.4	15.2	11.7	10.0	8.93	6.70	5.56	2.92
1.70V/cell	34.1	20.8	15.5	11.9	10.2	8.97	6.81	5.61	2.95

### Constant Power Discharge (Watts/cell) at 25 °C (77°F)

F.V/Time	1h	2h	3h	4h	5h	6h	8h	10h	20h
1.85V/cell	59.4	36.4	26.8	21.1	18.4	16.3	12.6	10.4	5.55
1.80V/cell	61.2	37.4	29.0	22.5	19.3	17.4	13.2	10.9	5.74
1.75V/cell	64.0	39.2	29.5	22.8	19.6	17.5	13.2	11.0	5.79
1.70V/cell	64.9	39.9	29.9	23.1	19.8	17.6	13.4	11.1	5.84



# LPC Series-Cycle Application

## LPC12-55(12V55Ah)

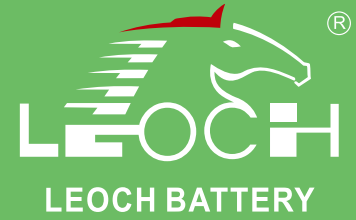

### Applications

- Electric tools
- Mobility Scooter
- Golf trolleys
- Portable lights and instruments
- Electric toys
- Portable power
- Electric wheelchair

### General Features

- Good cyclic property. Enhanced overcharge endurance and overdischarge recovery property
- Using oxygen recombination technology: maintenance-free
- Lower acid density, excess of electrolyte and larger distance between plates to keep battery at low temperature and slow down plate grid corrosion speed
- Unique plate group configuration, high quality AGM separator and battery management system ensure battery with a longer service life

### Standards

- ACC. to BCI standards
- Manufactured in Leoch® IATF 16949, ISO 9001, ISO 14001 and ISO 45001 certified production facilities

### Discharge Characteristics

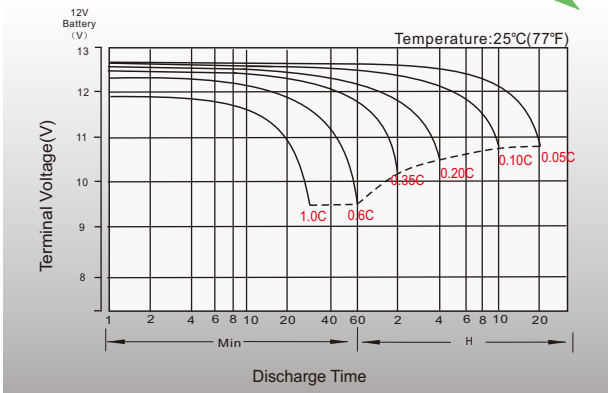

### Charging Characteristics

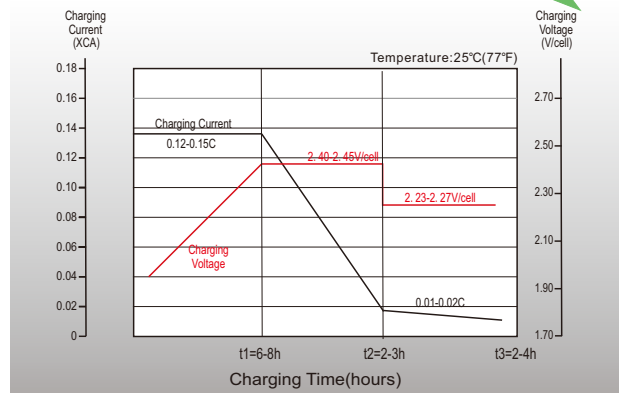

### Cycle Life in Relation to Depth of Discharge

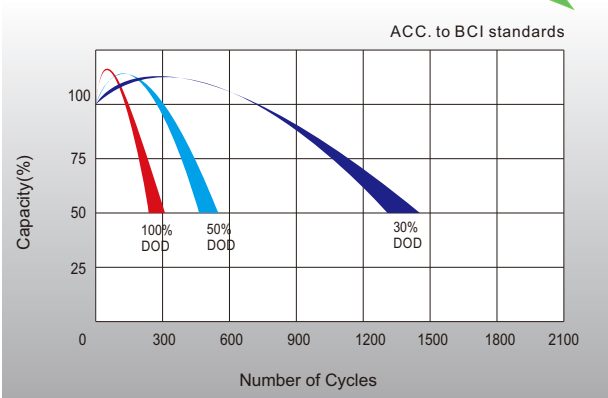

### Self Discharge Characteristics

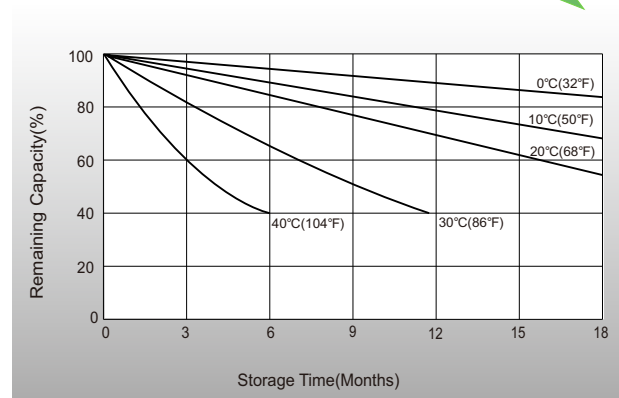

### Sales Offices Worldwide

#### China Sales Office

5th Floor, Xinbaohui Bldg., Nanhai Blvd.,  
Nanshan, Shenzhen, China. 518052  
Tel: +86-555-86036060 (100 lines)  
Fax: +86-555-26067269  
E-mail: export@leoch.com

#### HongKong Sales Office

Workshop C, 33/F, TML Tower, No. 3 Hoi Shing Road,  
Tsuen Wan, New Territories, Hong Kong  
Tel: +852 35786666  
Fax: +44 1452 690125  
E-mail: sales.hk@leoch.com

#### Singapore Sales Office

No. 1 Tech Park Crescent,  
Singapore 638131  
Tel: +65 68636078  
Fax: +65 6863 6079  
Email: sales.sg@Leoch.com

#### Australia Sales Office

2/29 Tarlington Place, Smithfield. NSW 2164  
Australia  
Tel: 02 9756 0950  
E-mail: sales.au@leoch.com

#### North America Sales Office

19751 Descartes  
Foothill Ranch, CA 92610, USA  
Tel: 949-588-5853  
Fax: 949-588-5966  
E-mail: sales@leoch.us  
Http://www.leoch.us

#### UK Sales Office

9B Wheatstone Court, Waterwells, Business Park,  
Gloucester, GL2-2AQ, UK United Kingdom  
Tel: +44(0) 1452 729428 / 1452 729696  
Fax: +44 1452 690125  
E-mail: Sales.Europe@leoch.com  
Http://www.leoch.eu

#### EMEA Sales Office

1 Deligiorgi St., 121 31 Athens,  
Greece  
Tel: +30 210 5760318 (2 lines)  
E-mail: support\_EMEA@leoch.com  
Http://www.leoch.eu

#### India Sales Office

Shed no. A-53(b), 2nd Stage of Peenya Industrial Area,  
Bangalore North Taluk, Bangalore-560058, India  
Tel: +91-80-23440018/23440019  
Fax: +91-80-23440017  
E-mail: indiasales@leoch.com



[Http://www.leoch.com](http://www.leoch.com)

© 2023 LEOCH. All rights reserved.

Trademarks and logos are the property of LEOCH and its affiliates unless otherwise noted.  
Subject to revisions without prior notice.

Publication No.: LB-LPC12-55-PD-EN-V2.3-202301