

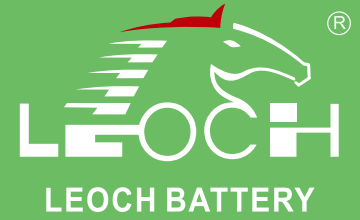

# LPC Series-Deep Cycle

## LPC12-100(12V100Ah)



### Specifications

Rated Voltage	12V		
Rated Capacity(C <sub>10</sub> , 1.80V/cell)	100Ah		
Dimensions	Length	330±2mm (13.0 inches)	
	Width	173±2mm (6.81 inches)	
	Container Height	212±2mm (8.35 inches)	
	Total Height	220±2mm (8.66 inches)	
Approx Weight	30.6Kg (67.5 lbs)		
Terminal	M8		
Container Material	ABS		
Nominal Capacity(25°C)	105.0Ah	(20hr, 5.25A, 1.80V/cell)	
	100.0Ah	(10hr, 10.0A, 1.80V/cell)	
	91.0Ah	(5hr, 18.2A, 1.75V/cell)	
	82.8Ah	(3hr, 27.6A, 1.75V/cell)	
	72.0Ah	(2hr, 37.0A, 1.75V/cell)	
Short Circuit Current	2000A		
Internal Resistance(25°C)	≤4.9mΩ		
Operating Temp. Range	Discharge	-20 ~ 55°C (-4 ~ 131°F)	
	Charge	0 ~ 40°C (32 ~ 104°F)	
	Storage	-20 ~ 50°C (-4 ~ 122°F)	
Nominal Operating Temp. Range	25±3°C (77±5°F)		
Max.Charging Current(25°C)	25A		
Charge voltage(25°C)	Charge Voltage	Temp. Coefficient	
	Float	2.23~2.27V/cell	-3mV/cell/°C
Effect of temp. to Capacity	Cycle	2.40~2.45V/cell	-4mV/cell/°C
	40°C (104°F)	106%	
	25°C (77°F)	100%	
	0°C (32°F)	86%	
Self Discharge	≤3%/month @ 25°C		



### Layout

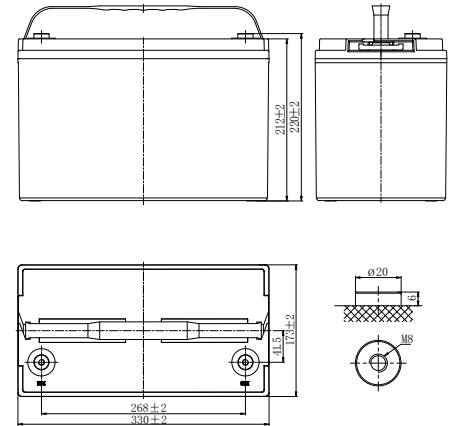

### Constant Current Discharge (Amperes) at 25 °C (77°F)

F.V/Time	15min	30min	1h	2h	3h	4h	5h	6h	8h	10h	20h
1.85V/cell	128.3	90.2	55.9	34.0	25.0	19.6	17.0	15.0	11.5	9.55	5.07
1.80V/cell	145.4	98.2	57.9	35.2	27.1	20.9	17.9	15.7	12.1	10.0	5.25
1.75V/cell	157.4	100.2	60.7	37.0	27.6	21.3	18.2	15.8	12.2	10.1	5.30
1.70V/cell	167.1	102.2	61.9	37.7	28.2	21.7	18.5	16.0	12.4	10.2	5.36
1.67V/cell	172.0	103.7	62.8	38.3	28.4	22.0	18.9	16.3	12.6	10.3	5.42
1.60V/cell	177.3	105.2	63.8	38.9	28.7	22.3	19.1	16.3	12.7	10.5	5.49

### Constant Power Discharge (Watts/cell) at 25 °C (77°F)

F.V/Time	15min	30min	1h	2h	3h	4h	5h	6h	8h	10h	20h
1.85V/cell	242.9	172.3	108.1	66.2	48.8	38.4	33.5	29.7	22.9	19.0	10.1
1.80V/cell	271.7	186.2	111.3	68.0	52.7	40.9	35.1	30.9	24.0	19.9	10.4
1.75V/cell	289.9	188.5	116.3	71.3	53.6	41.5	35.6	31.1	24.1	20.0	10.5
1.70V/cell	304.8	190.7	118.0	72.5	54.4	42.1	36.1	31.4	24.4	20.2	10.6
1.67V/cell	309.8	192.0	119.0	73.2	54.7	42.6	36.7	31.7	24.7	20.4	10.7
1.60V/cell	314.1	192.8	119.9	73.8	54.9	42.9	37.0	31.8	25.0	20.6	10.9



# LPC Series-Deep Cycle

## LPC12-100(12V100Ah)

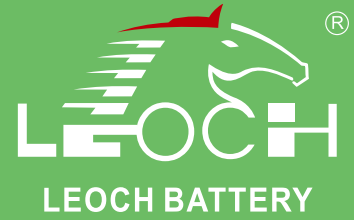

### Applications

- Electric tools
- Mobility Scooter
- Golf trolleys
- Portable lights and instruments
- Electric toys
- Portable power
- Electric wheelchair

### General Features

- Good cyclic property. Enhanced overcharge endurance and overdischarge recovery property
- Using oxygen recombination technology: maintenance-free
- Lower acid density, excess of electrolyte and larger distance between plates to keep battery at low temperature and slow down plate grid corrosion speed
- Unique plate group configuration, high quality AGM separator and battery management system ensure battery with a longer service life

### Standards

- Compliance with BCI standards
- Manufactured in Leoch® IATF 16949, ISO 9001, ISO 14001 and ISO 45001 certified production facilities

### Discharge Characteristics

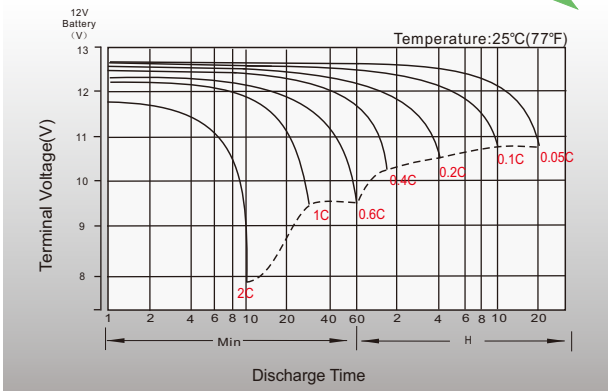

### Charging Characteristics

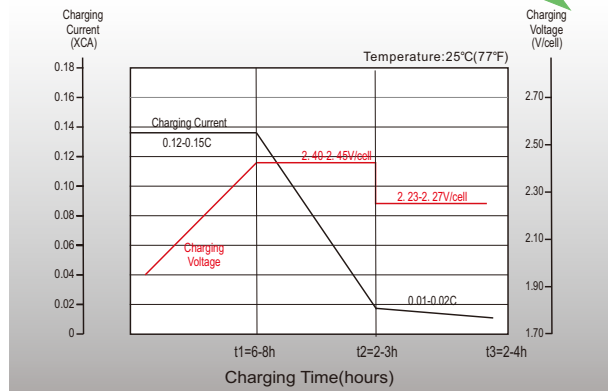

### Cycle Life in Relation to Depth of Discharge

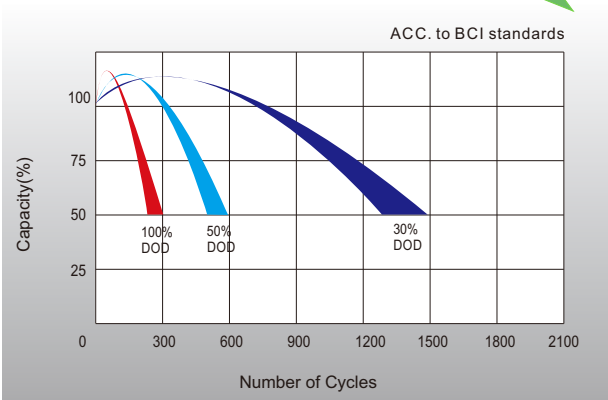

### Self Discharge Characteristics

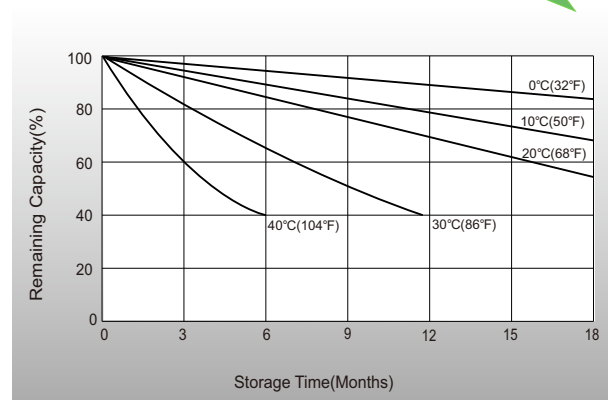

### Sales Offices Worldwide

#### China Sales Office

5th Floor, Xinbaohui Bldg., Nanhai Blvd.,  
Nanshan, Shenzhen, China. 518052  
Tel: +86-755-86036060 (100 lines)  
Fax: +86-755-26067269  
E-mail: export@leoch.com

#### HongKong Sales Office

Workshop C, 33/F, TML Tower, No. 3 Hoi Shing Road,  
Tsuen Wan, New Territories, Hong Kong  
Tel: +852 35786666  
Fax: +44 1452 690125  
E-mail: sales.hk@leoch.com

#### Singapore Sales Office

No. 1 Tech Park Crescent,  
Singapore 638131  
Tel: +65 68636078  
Fax: +65 6863 6079  
Email: sales.sg@Leoch.com

#### Australia Sales Office

2/29 Tarlington Place, Smithfield. NSW 2164  
Australia  
Tel: 02 9756 0950  
E-mail: sales.au@leoch.com

#### North America Sales Office

19751 Descartes  
Foothill Ranch, CA 92610, USA  
Tel: 949-588-5853  
Fax: 949-588-5966  
E-mail: sales@leoch.us  
Http://www.leoch.us

#### UK Sales Office

9B Wheatstone Court, Waterwells, Business Park,  
Gloucester, GL2-2AQ, UK United Kingdom  
Tel: +44(0) 1452 729428 / 1452 729696  
Fax: +44 1452 690125  
E-mail: Sales.Europe@leoch.com  
Http://www.leoch.eu

#### EMEA Sales Office

1 Deligiorgi St., 121 31 Athens,  
Greece  
Tel: +30 210 5760318 (2 lines)  
E-mail: support\_EMEA@leoch.com  
Http://www.leoch.eu

#### India Sales Office

Shed no. A-53(b), 2nd Stage of Peenya Industrial Area,  
Bangalore North Taluk, Bangalore-560058, India  
Tel: +91-80-23440018/23440019  
Fax: +91-80-23440017  
E-mail: indiasales@leoch.com



[Http://www.leoch.com](http://www.leoch.com)

© 2022 LEOCH. All rights reserved.

Trademarks and logos are the property of LEOCH and its affiliates unless otherwise noted.  
Subject to revisions without prior notice.

Publication No.: LB-LPC12-100-PD-EN-V2.2-202212