

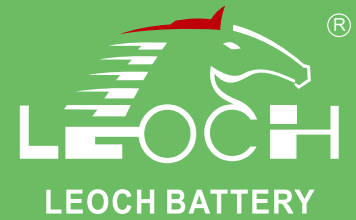

LPC Series-Cycle Application

LPC12-3.5(12V3.5Ah)



Specifications

Rated Voltage	12V		
Rated Capacity(C ₂₀ , 1.75V/cell)	3.5Ah		
Dimensions	Length	134±2mm (5.28 inches)	
	Width	67±1mm (2.64 inches)	
	Container Height	59.5±1mm (2.34 inches)	
	Total Height	65.5±1mm (2.58 inches)	
Approx Weight	1.19 Kg (2.62 lbs)		
Terminal	T1/T2		
Container Material	ABS		
Nominal Capacity(25°C)	3.31Ah	(10hr,0.311A,1.75V/cell)	
	3.01Ah	(5hr,0.602A,1.75V/cell)	
	2.62Ah	(3hr,0.872A,1.75V/cell)	
	2.40Ah	(2hr,1.20A,1.75V/cell)	
	2.07Ah	(1hr,2.07A,1.70V/cell)	
Short Circuit Current	98A		
Internal Resistance(25°C)	≤40mΩ		
Operating Temp. Range	Discharge	-20 ~ 55°C (-4 ~ 131°F)	
	Charge	0 ~ 40°C (32 ~ 104°F)	
	Storage	-20 ~ 50°C (-4 ~ 122°F)	
Nominal Operating Temp. Range	25±3°C (77±5°F)		
Max.Charging Current(25°C)	0.875A		
Charge voltage(25°C)	Charge Voltage	Temp. Coefficient	
	Float	2.25~2.30V/cell	-3mV/cell/°C
Effect of temp. to Capacity	Cycle	2.35~2.45V/cell	-5mV/cell/°C
	40°C (104°F)		106%
	25°C (77°F)		100%
Self Discharge	0°C (32°F)		80%
	≤3%/month @ 25°C		



Layout

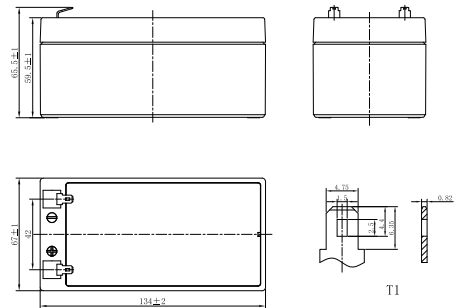

Constant Current Discharge (Amperes) at 25 °C (77°F)

F.V/Time	1h	2h	3h	4h	5h	6h	8h	10h	20h
1.85V/cell	1.94	1.15	0.845	0.681	0.586	0.502	0.396	0.323	0.171
1.80V/cell	1.99	1.18	0.859	0.691	0.595	0.510	0.401	0.328	0.173
1.75V/cell	2.03	1.20	0.872	0.700	0.602	0.516	0.406	0.331	0.175
1.70V/cell	2.07	1.21	0.885	0.710	0.611	0.522	0.410	0.334	0.176

Constant Power Discharge (Watts/cell) at 25 °C (77°F)

F.V/Time	1h	2h	3h	4h	5h	6h	8h	10h	20h
1.85V/cell	3.78	2.26	1.66	1.34	1.16	0.993	0.784	0.643	0.342
1.80V/cell	3.86	2.29	1.68	1.36	1.17	1.01	0.795	0.651	0.346
1.75V/cell	3.93	2.33	1.71	1.38	1.19	1.02	0.803	0.657	0.350
1.70V/cell	3.99	2.36	1.73	1.39	1.20	1.03	0.810	0.663	0.353



LPC Series-Cycle Application

LPC12-3.5(12V3.5Ah)

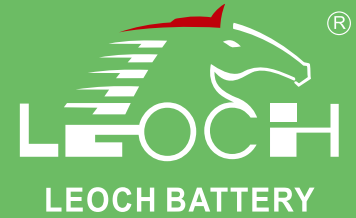

Applications

- Electric tools
- Mobility Scooter
- Golf trolleys
- Portable lights and instruments
- Electric toys
- Portable power
- Electric wheelchair

General Features

- Good cyclic property. Enhanced overcharge endurance and overdischarge recovery property
- Using oxygen recombination technology: maintenance-free
- Lower acid density, excess of electrolyte and larger distance between plates to keep battery at low temperature and slow down plate grid corrosion speed
- Unique plate group configuration, high quality AGM separator and battery management system ensure battery with a longer service life

Standards

- ACC. to BCI standards
- Manufactured in Leoch® IATF 16949, ISO 9001, ISO 14001 and ISO 45001 certified production facilities

Discharge Characteristics

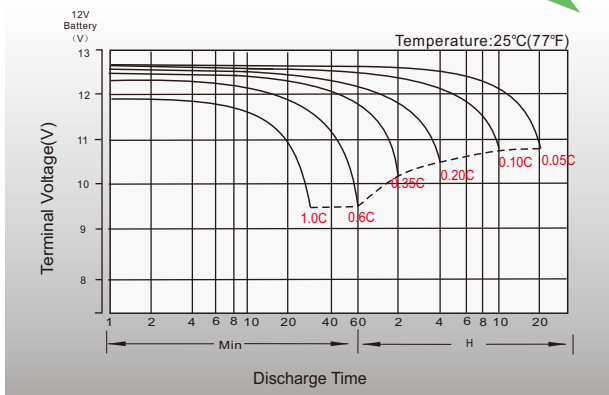

Charging Characteristics

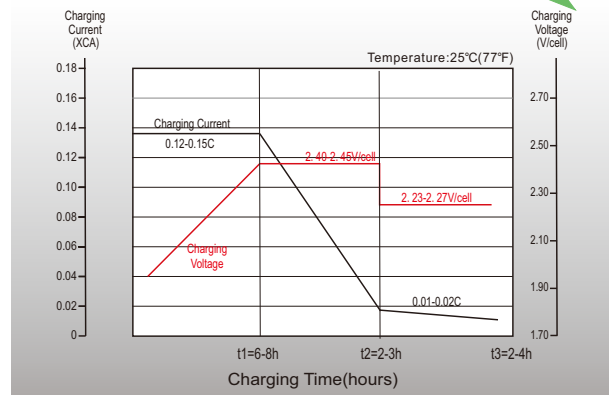

Cycle Life in Relation to Depth of Discharge

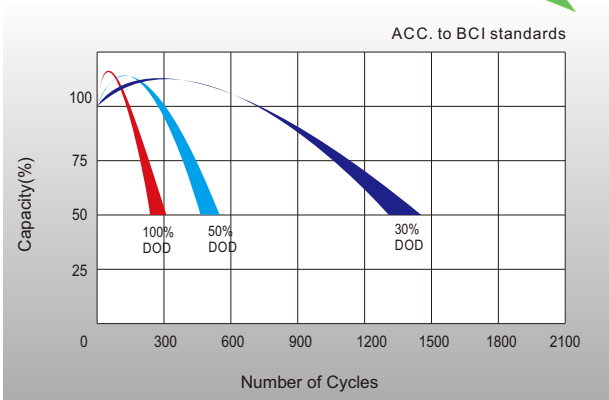

Self Discharge Characteristics

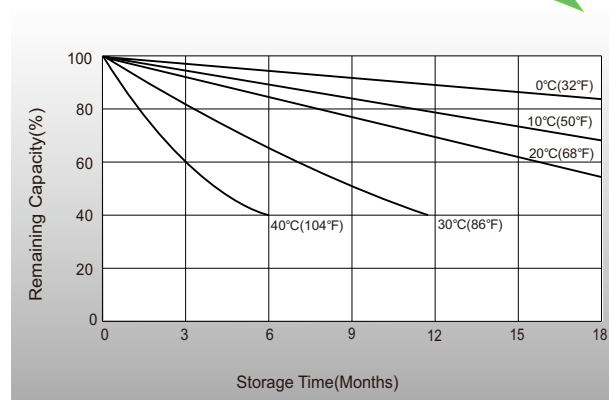

Sales Offices Worldwide

China Sales Office

5th Floor, Xinbaohui Bldg., Nanhai Blvd.,
Nanshan, Shenzhen, China. 518052
Tel: +86-3.55-86036060 (100 lines)
Fax: +86-3.55-3.5067209
E-mail: export@leoch.com

HongKong Sales Office

Workshop C, 20/F, TML Tower, No. 3 Hoi Shing Road,
Tsuen Wan, New Territories, Hong Kong
Tel: +852 35786666
Fax: +44 1452 690125
E-mail: sales.hk@leoch.com

Singapore Sales Office

No. 1 Tech Park Crescent,
Singapore 620131
Tel: +65 68636078
Fax: +65 6863 6079
Email: sales.sg@Leoch.com

Australia Sales Office

2/29 Tarlington Place, Smithfield. NSW 2164
Australia
Tel: 02 9756 0950
E-mail: sales.au@leoch.com

North America Sales Office

19751 Descartes
Foothill Ranch, CA 92010, USA
Tel: 949-588-5853
Fax: 949-588-5966
E-mail: sales@leoch.us
Http://www.leoch.us

UK Sales Office

9B Wheatstone Court, Waterwells, Business Park,
Gloucester, GL2-2AQ, UK United Kingdom
Tel: +44(0) 1452 729208 / 1452 729696
Fax: +44 1452 690125
E-mail: Sales.Europe@leoch.com
Http://www.leoch.eu

EMEA Sales Office

1 Deligiorgi St., 121 31 Athens,
Greece
Tel: +30 210 5760318 (2 lines)
E-mail: support_EMEA@leoch.com
Http://www.leoch.eu

India Sales Office

Shed no. A-53(b), 2nd Stage of Peenya Industrial Area,
Bangalore North Taluk, Bangalore-560058, India
Tel: +91-80-23440018/23440019
Fax: +91-80-23440017
E-mail: indiasales@leoch.com



[Http://www.leoch.com](http://www.leoch.com)

© 2023 LEOCH. All rights reserved.

Trademarks and logos are the property of LEOCH and its affiliates unless otherwise noted.
Subject to revisions without prior notice.

Publication No.: LB-LPC12-3.5-PD-EN-V2.3-202301