



LPG Series-Gel Battery

LPG12-200(12V200Ah)



Specifications

Rated Voltage	12V	
Nominal Capacity	C ₂₀ , 1.80V/cell	200Ah
Dimension	Length	522±2mm (20.6 inches)
	Width	240±2mm (9.45 inches)
	Container Height	218±2mm (8.58 inches)
	Total Height	224±2mm (8.81 inches)
Approx Weight	62.3kg (137.4 lbs)	
Terminal	M8	
Container Material	ABS	
Rated Capacity(25°C)	200.0 Ah	C20(10.0A, 1.80V/cell)
	190.0 Ah	C10(19.0A, 1.80V/cell)
	165.5 Ah	C5(33.1A, 1.75V/cell)
	148.2 Ah	C3(49.4A, 1.75V/cell)
	120.3 Ah	C1(120.3A, 1.60V/cell)
Max. Discharge Current	2000A (5s)	
Internal Resistance(25°C)	Approx 4.6mΩ	
Operating Temp. Range	Discharge	-20 ~ 55°C (-4 ~ 131°F)
	Charge	-20 ~ 40°C (-4 ~ 104°F)
	Storage	-15 ~ 50°C (5 ~ 122°F)
Nominal Operating Temp. Range	25±3°C (77±5°F)	
Standby Use	Initial Charging Current less than 50A. Voltage 2.23V~2.27V at 25°C(77°F)Temp. Coefficient -3mV/°C	
	Equalization Use	
Cycle Use	Initial Charging Current less than 50A. Voltage 2.30V~2.37V at 25°C(77°F)Temp. Coefficient -4mV/°C	
	Initial Charging Current less than 50A. Voltage 2.40V~2.50V at 25°C(77°F)Temp. Coefficient -5mV/°C	
Effect of temp. to Capacity	40°C (104°F)	103%
	25°C (77°F)	100%
	0°C (32°F)	86%
Self Discharge	LPG series batteries may be stored for up to 6 months at 25°C(77°F) and then a freshening charge is required. For higher temperatures the time interval will be shorter.	

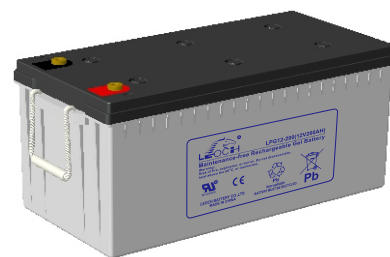

Layout

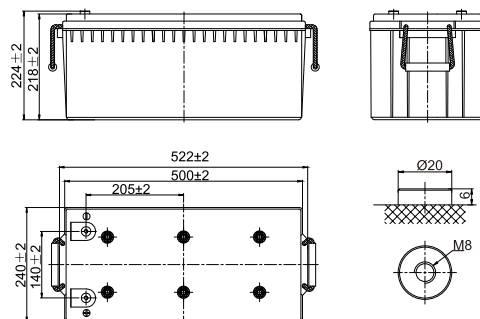

Constant Current Discharge (Amperes) at 25°C (77°F)

F.V/Time	10min	15min	20min	30min	45min	1h	1.5h	2h	3h	4h	5h	6h	8h	10h	20h
1.85V/cell	250.0	216.8	170.5	154.2	112.8	89.3	69.2	55.2	43.8	35.6	31.0	27.1	22.0	18.6	9.62
1.80V/cell	283.8	245.7	192.7	166.7	119.5	98.8	73.5	60.8	48.1	38.7	32.6	28.7	22.9	19.0	10.0
1.75V/cell	292.7	255.6	201.0	167.9	121.4	108.7	78.8	63.9	49.4	39.3	33.1	29.2	23.1	19.4	10.3
1.70V/cell	307.8	266.0	208.1	171.3	123.8	110.8	80.4	65.2	50.1	39.9	33.6	29.6	23.3	19.6	10.4
1.67V/cell	338.6	290.7	226.7	177.3	128.1	116.5	84.0	67.8	51.6	40.6	34.6	30.1	23.7	19.8	10.6
1.60V/cell	350.2	299.7	232.5	179.9	130.0	120.3	86.3	69.3	52.3	41.3	35.3	30.6	23.9	20.0	10.8

Constant Power Discharge (Watts/cell) at 25°C (77°F)

F.V/Time	10min	15min	20min	30min	45min	1h	1.5h	2h	3h	4h	5h	6h	8h	10h	20h
1.85V/cell	470.4	410.5	324.3	294.7	216.8	173.6	134.8	107.9	86.0	70.0	61.0	53.5	43.5	36.9	19.2
1.80V/cell	526.2	459.2	362.7	315.5	228.2	190.7	142.4	118.2	94.0	75.8	64.1	56.4	45.2	37.5	19.9
1.75V/cell	540.3	475.3	376.6	318.3	231.8	208.9	152.3	124.1	96.1	76.7	64.9	57.4	45.5	38.3	20.5
1.70V/cell	561.6	490.0	387.1	322.3	235.1	212.3	154.9	126.2	97.3	77.8	65.8	58.1	45.8	38.6	20.6
1.67V/cell	600.0	523.6	413.6	328.4	240.3	220.7	160.2	130.0	99.6	78.8	67.3	58.7	46.5	38.9	21.0
1.60V/cell	608.4	530.9	419.4	329.8	241.5	225.7	163.1	131.8	100.3	79.7	68.5	59.4	46.7	39.2	21.3



LPG Series-Gel Battery

LPG12-200(12V200Ah)

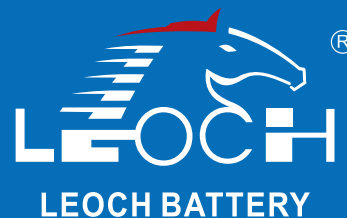

Applications

- Telecommunications
- Solar system
- Wind power system
- Engine starting
- Wheelchair, Floor cleaning machines, Golf trolley, Boats

General Features

- Battery design life up to 12 years
- Special plate design guarantees battery floating life more than 4000 times
- High thermal capacity reduce the risk of thermal out of control and drying hard, and the battery can be used in bad environment
- Little water losing, and no electrolyte stratification phenomenon

Standards

- IEC 60896 Certified
- Classified as "Long Life" according to Eurobat
- UL ,CE Certified
- Manufactured in Leoch@ IATF16949, ISO 9001, ISO 14001 and ISO 45001 certified production facilities

Discharge Characteristics

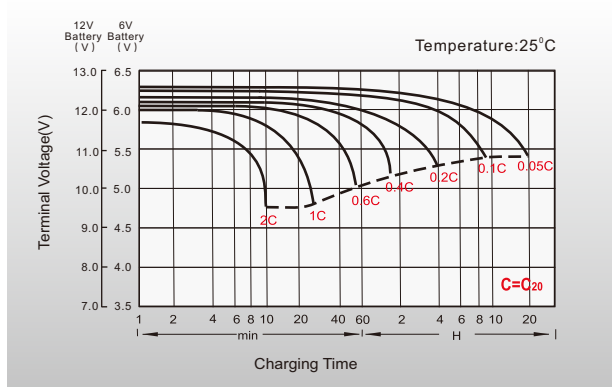

Float Charging Characteristics

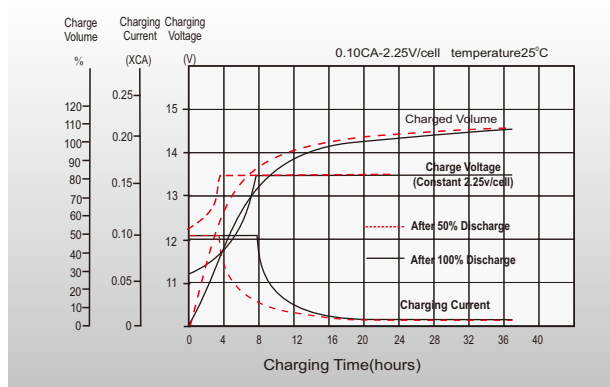

Cycle Life in Relation to Depth of Discharge

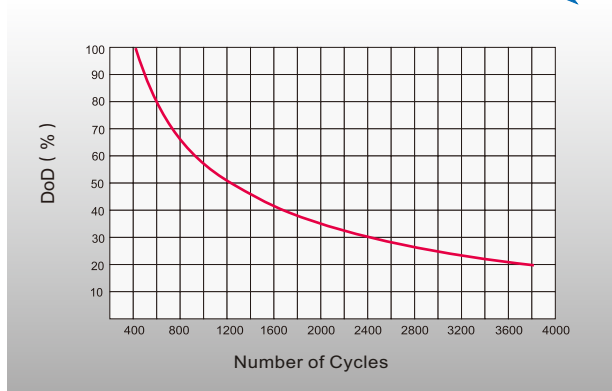

Effect of Temperature on Long Term Float Life

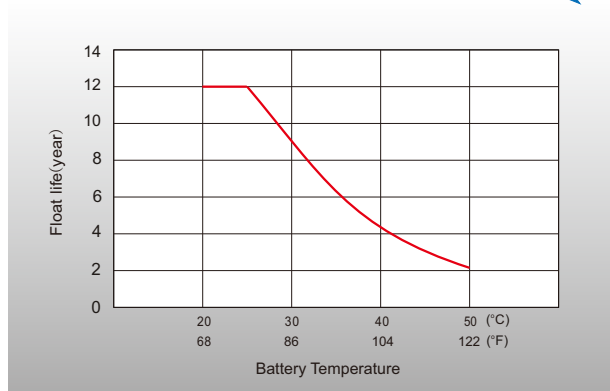

Sales Offices Worldwide

China Sales Office

5th Floor, Xinbaohui Bldg., Nanhai Blvd.,
Nanshan, Shenzhen, China. 518052
Tel: +86-755-86036060 (100 lines)
Fax: +86-755-26067269
E-mail: export@leoch.com

HongKong Sales Office

Workshop C, 33/F, TML Tower, No. 3 Hoi Shing Road,
Tsuen Wan, New Territories, Hong Kong
Tel: +852 35786666
Fax: +44 1452 690125
E-mail: sales.hk@leoch.com

Singapore Sales Office

No. 1 Tech Park Crescent,
Singapore 638131
Tel: +65 68636078
Fax: +65 6863 6079
Email: sales.sg@Leoch.com

Australia Sales Office

2/29 Tarlington Place, Smithfield. NSW 2164
Australia
Tel: 02 9756 0950
E-mail: sales.au@leoch.com

North America Sales Office

19751 Descartes
Foothill Ranch, CA 92610, USA
Tel: 949-588-5853
Fax: 949-588-5966
E-mail: sales@leoch.us
Http://www.leoch.us

UK Sales Office

9B Wheatstone Court, Waterwells, Business Park,
Gloucester, GL2-2AQ, UK United Kingdom
Tel: +44(0) 1452 729428 / 1452 729696
Fax: +44 1452 690125
E-mail: Sales.Europe@leoch.com
Http://www.leoch.eu

EMEA Sales Office

1 Deligiorgi St., 121 31 Athens,
Greece
Tel: +30 210 5760318 (2 lines)
E-mail: support_EMEA@leoch.com
Http://www.leoch.eu

India Sales Office

Shed no.A-53(b), 2nd Stage of Peenya Industrial Area,
Bangalore North Taluk, Bangalore-560058, India
Tel: +91-80-23440018/23440019
Fax: +91-80-23440017
E-mail: indiasales@leoch.com



[Http://www.leoch.com](http://www.leoch.com)

© 1999-2023 LEOCH. All rights reserved.

Trademarks and logos are the property of LEOCH and its affiliates unless otherwise noted.

Subject to revisions without prior notice E& OE.

Publication No.: LB-LPG12-200-PD-EN-V2.3-202302