



LRC Series-Lead Carbon

LRC2-1000



Specifications

Rated Voltage	2V	
Nominal Capacity	1000Ah	(C ₁₀₀ , 1.80V/cell)
Dimension	Length	440mm (17.32 in.)
	Width	181mm (7.13 in.)
	Container Height	350mm (13.78 in.)
	Total Height	365mm (14.37 in.)
Approx Weight	75.8Kg (167.1lbs)	
Terminal	M8	
Container Material	ABS Flame Retardant Material to UL94V-0	
Rated Capacity (25°C)	1308.0 Ah	C120(10.9A, 1.85V/cell)
	1000.0 Ah	C10(100.0A, 1.80V/cell)
	750.0 Ah	C3(250.0A, 1.80V/cell)
	550.0 Ah	C1(550.0A, 1.75V/cell)
Short Circuit Current	7280A	
Internal Resistance(25°C)	Approx.0.23mΩ	
Operating Temp.Range	Discharge	-20°C~55°C (-4°F~131°F)
	Charge	-20°C~40°C (-4°F~104°F)
	Storage	-20°C~50°C (-4°F~122°F)
Nominal Operating Temp. Range	25±3°C (77±5°F)	
Max.Discharging Current(25°C)	500.0A	
Max.Charging Current(25°C)	300.0A	
Charge voltage(25°C)	Cycle(Equalization)	2.30~2.40V
	Temp. Coefficient	-4mV/cell/°C
Effect of temp. to Capacity	40°C (104°F)	106%
	25°C (77°F)	100%
	0°C (32°F)	86%
Self Discharge	≤3.5% per month at 25°C	

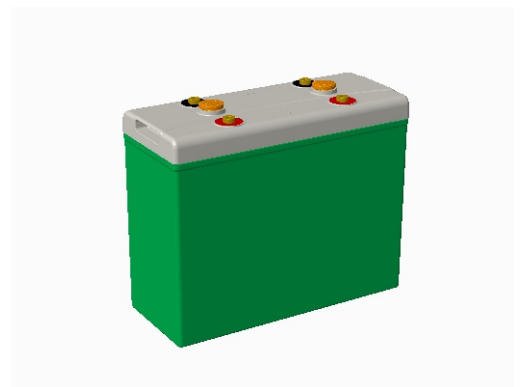

Layout

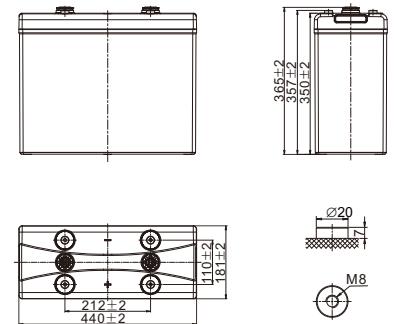

Constant Current Discharge (Amperes) at 25 °C (77° F)

F.V/Time	1h	2h	3h	4h	5h	6h	8h	10h	24h	36h	48h	60h	72h	84h	96h	108h	120h	240h
1.90V/cell	395.2	274.1	207.5	176.9	148.0	128.2	103.9	89.3	44.1	29.9	22.9	/	/	/	/	/	/	5.50
1.85V/cell	428.0	294.0	228.4	189.1	158.8	138.0	112.4	97.1	48.0	32.5	25.0	20.0	17.0	14.8	13.0	12.0	10.9	/
1.80V/cell	512.4	311.2	250.0	195.7	164.2	142.5	116.0	100.0	49.0	33.2	25.5	/	/	/	/	/	/	/
1.75V/cell	550.0	325.4	257.9	200.4	167.9	145.7	118.3	101.9	50.0	33.8	26.0	/	/	/	/	/	/	/

Constant Power Discharge (Watts/cell) at 25 °C (77° F)

F.V/Time	1h	2h	3h	4h	5h	6h	8h	10h	24h	36h	48h	60h	72h	84h	96h	108h	120h	240h
1.90V/cell	774.5	543.4	416.8	356.7	299.0	259.5	210.9	181.7	86.2	58.4	44.8	/	/	/	/	/	/	11.0
1.85V/cell	841.0	574.8	454.1	377.3	317.3	276.0	225.4	195.0	90.2	61.0	46.9	40.0	34.0	29.6	26.0	24.0	21.8	/
1.80V/cell	988.0	604.3	491.5	390.5	328.3	285.6	233.2	201.7	93.1	63.0	48.4	/	/	/	/	/	/	/
1.75V/cell	1039.4	628.1	503.7	397.0	333.4	289.7	236.1	203.9	95.1	64.4	49.4	/	/	/	/	/	/	/



LRC Series-Lead Carbon

LRC2-1000

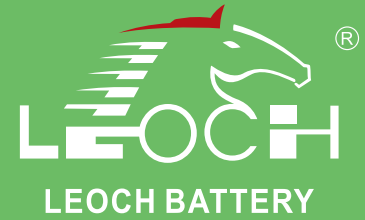

Applications

- Mobile container storage system
- Peak load shifting energy storage system
- Load tracking energy storage system
- Oil and electricity hybrid energy storage system
- Grid frequency adjustment energy storage system
- New energy communication base station, IDC, UPS etc.
- New energy generation (solar, wind, PV/wind hybrid) access to energy storage systems

General Features

- Design life ≥ 15 years
- Adopt super carbon technology + deep cycle technology
- Excellent charging acceptance and super fast charge/large discharge performance
- Modular design and installation for less space, easy installation & maintenance
- Innovative robust design to ensure superb safety and reliability
- Horizontal installation, solve the problem of electrolyte stratification

Standards

- Compliance with IEC 61427, BS EN 61427 standards
- UL, CE Certified
- Manufactured in Leoch@TS16949, IOS 45001, IOS 9001 and ISO14001 certified production facilities

Discharge Characteristics

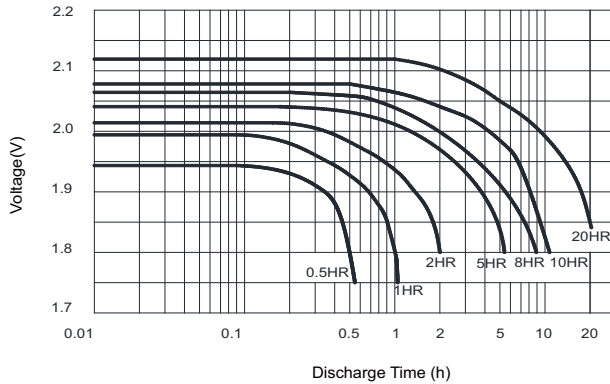

Temperature effects in relation to battery capacity

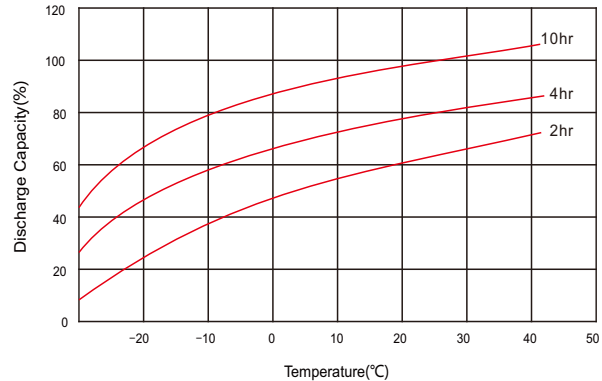

Cycle Life in Relation to DOD

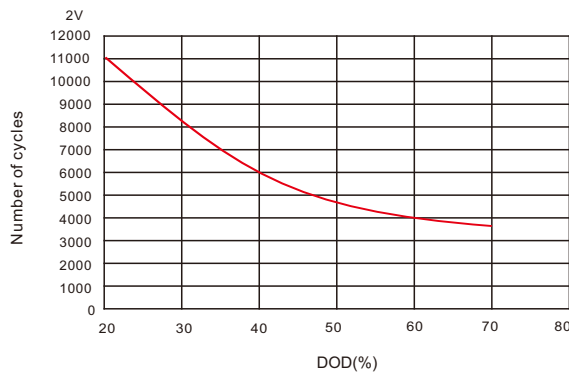

Self Discharge Characteristics

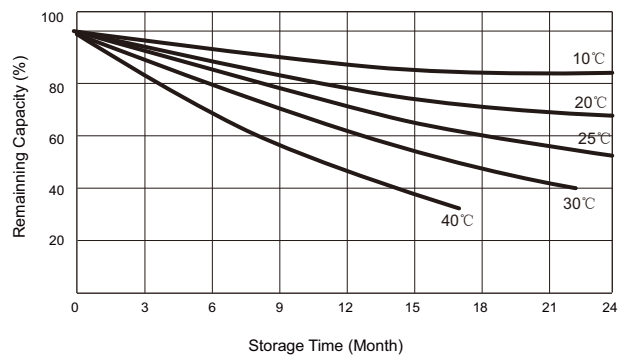

Sales Offices Worldwide

China Sales Office

5th Floor, Xinhaohui Bldg., Nanhai Blvd.,
Nanshan, Shenzhen, China. 518052
Tel: +86-755-86036060 (100 lines)
Fax: +86-755-26067269
E-mail: export@leoch.com

HongKong Sales Office

Workshop C, 33/F, TML Tower, No. 3 Hoi Shing Road,
Tsuen Wan, New Territories, Hong Kong
Tel: +852 35786666
Fax: +44 1452 690125
E-mail: sales.hk@leoch.com

Singapore Sales Office

No. 1 Tech Park Crescent,
Singapore 638131
Tel: +65 68636078
Fax: +65 6863 6079
Email: sales.sg@Leoch.com

Australia Sales Office

2/29 Tarlington Place, Smithfield. NSW 2164
Australia
Tel: 02 9756 0950
E-mail: sales.au@leoch.com

North America Sales Office

19751 Descartes
Foothill Ranch, CA 92610, USA
Tel: 949-588-5853
Fax: 949-588-5966
E-mail: sales@leoch.us

UK Sales Office

9B Wheatstone Court. Waterwells, Business Park,
Gloucester, GL2-2AQ, UK United Kingdom
Tel: +44(0) 1452 729428 / 1452 729696
Fax: +44 1452 690125
E-mail: Sales.Europe@leoch.com

EMEA Sales Office

1 Deligiorgi St., 121 31 Athens,
Greece
Tel: +30 210 5760318 (2 lines)
E-mail: support_EMEA@leoch.com

India Sales Office

Shed no.A-53(b), 2nd Stage of Peenya Industrial Area,
Bangalore North Taluk, Bangalore-560058, India
Tel: +91-80-23440018/23440019
Fax: +91-80-23440017
E-mail: indiasales@leoch.com



<http://www.leoch.com>

<http://www.leoch.us>

© 2020 LEOCH. All rights reserved.

Trademarks and logos are the property of LEOCH and its affiliates unless otherwise noted.
Subject to revisions without prior notice.

Publication No.:LB-LRC2-1000-PD-EN-V1.2-202005