



PLH-Pure Lead Long Standby Life

PLH90FT(A) (12V90Ah)



Specifications

Rated Voltage	12V	
Nominal Capacity	C ₁₀ , 1.80V/cell	90Ah
	C ₈ , 1.75V/cell	90Ah
Dimension	Length	405.4±2mm (15.96 inches)
	Width	108±2mm (4.25 inches)
	Container Height	287±2mm (11.30 inches)
	Total Height	287±2mm (11.30 inches)
Approx. Weight	28.7 Kg (63.3 lbs)	
Terminal	M6	
Container Material	PC-ABS flame retardant jar and cover to UL94 V-0	
Rated Capacity (25°C)	94.4 Ah	(20hr, 4.72A, 1.80V/cell)
	90.0 Ah	(10hr, 9.00A, 1.80V/cell)
	83.0 Ah	(5hr, 16.6A, 1.75V/cell)
	80.4 Ah	(3hr, 26.8A, 1.75V/cell)
	62.3 Ah	(1hr, 62.3A, 1.67V/cell)
Max. Discharge Current	1080A	
Internal Resistance (25°C)	Approx. 4.6mΩ(Fully charged)	
Operating Temp. Range	Discharge	-40 ~ 65°C (-40 ~ 149°F)
	Charge	0 ~ 54°C (32 ~ 129°F)
	Storage	-20 ~ 40°C (-4 ~ 104°F)
Nominal Operating Temp. Range	25±3°C (77±5°F)	
Max. Charging Current(25°C)	27.0A	
Charge voltage(25°C)	Float	13.62V
	Temp. Coefficient	-3mV/cell/°C
	Equalization	14.1~14.4V
Effect of temp. to Capacity	40°C (104°F)	103%
	25°C (77°F)	100%
	0°C (32°F)	86%
Self Discharge	<p>PLH series batteries can be stored up to 24 months at 25°C(77°F), For higher temperatures the time interval will be shorter.</p> <p>Battery needs to be given a freshening charge when the OCV approach 2.10V/cell or when the maximum storage time is reached, whichever occurs first.</p>	



Layout

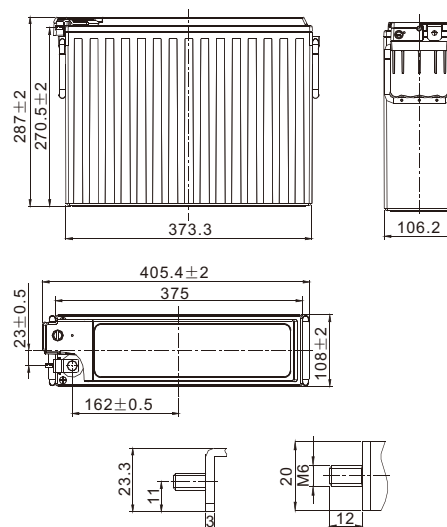

Unit: mm

Constant Current Discharge (Amperes) at 25 °C (77° F)

F.V/Time	10 min	15min	20min	30min	45min	1h	2h	3h	4h	5h	8h	10h	20h
1.85V/cell	174.2	145.4	124.6	99.2	74.3	54.7	35.3	25.1	20.1	16.2	10.7	8.92	4.61
1.80V/cell	195.8	162.6	134.8	104.0	78.6	57.0	36.6	26.1	20.3	16.4	11.0	9.00	4.72
1.75V/cell	213.0	171.4	144.2	110.8	82.2	59.1	37.7	26.8	20.6	16.6	11.3	9.18	4.77
1.70V/cell	227.4	181.3	151.8	115.2	85.1	60.6	38.4	27.0	20.8	16.7	11.3	9.36	4.84
1.67V/cell	242.4	188.6	155.6	119.3	86.4	62.3	38.9	27.8	21.0	17.2	11.5	9.72	4.88
1.60V/cell	256.0	197.4	161.6	120.4	88.1	63.4	39.2	28.1	21.1	17.5	11.7	9.90	4.96

Constant Power Discharge (Watts/cell) at 25 °C (77° F)

F.V/Time	10 min	15min	20min	30min	45min	1h	2h	3h	4h	5h	8h	10h	20h
1.85V/cell	332.3	278.1	239.8	193.1	146.8	108.4	70.4	50.3	40.4	32.7	21.7	18.2	9.42
1.80V/cell	367.5	306.9	256.8	201.1	154.5	112.3	72.5	52.1	40.7	33.0	22.2	18.3	9.62
1.75V/cell	395.8	320.5	272.5	212.6	160.3	115.9	74.3	53.1	41.2	33.3	22.8	18.6	9.69
1.70V/cell	416.1	334.9	284.1	219.2	165.0	118.1	75.2	53.2	41.4	33.4	22.7	18.9	9.82
1.67V/cell	439.2	344.9	288.7	226.0	166.9	121.0	76.0	54.5	41.7	34.3	23.1	19.5	9.88
1.60V/cell	451.5	353.4	295.0	225.2	168.3	122.0	75.8	54.6	41.5	34.6	23.3	19.8	10.0



PLH-Pure Lead Long Standby Life

PLH90FT(A) (12V90Ah)



Applications

- Telecommunication
- Railway signal
- Alarm and security system
- Power station systems
- Emergency power supply

General Features

- 20 years design life(25°C)
- Premium ABS+PC jar & covers, Flame Retardant to UL94 V-0
- High-rate performance, high energy density
- High quality AGM separators minimize electrical resistance to allow high current discharging properties

Standards

- Compliance with IEC 60896 standards
- Classified as "Very Long Life" according to Eurobat
- CE, UL Certified
- Manufactured in Leoch@IATF16949, OHSAS 18001,ISO 9001 and ISO 14001 certified production facilities

Discharge Characteristics

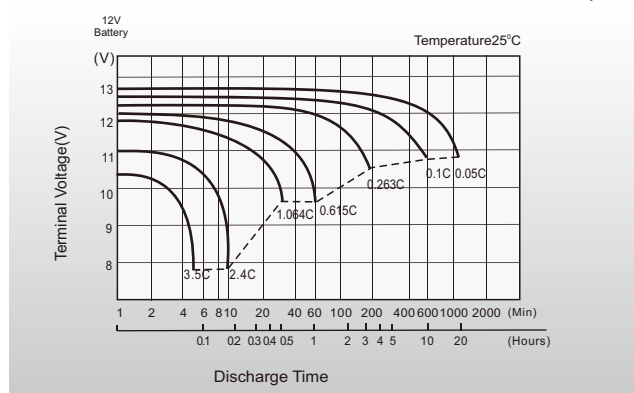

Float Charging Characteristics

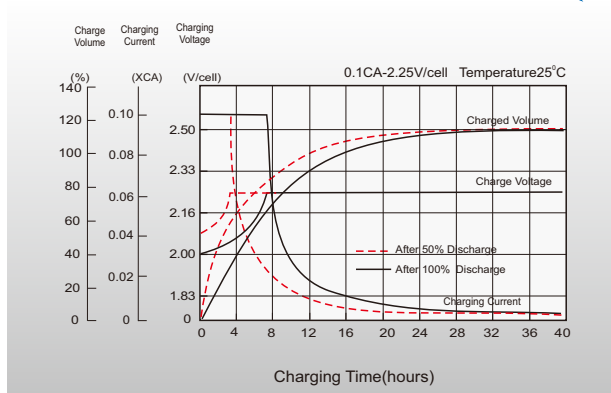

Effects of Temperature on Discharging Time

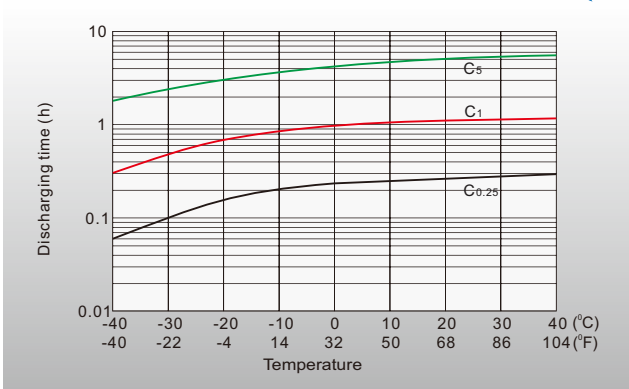

Float Life

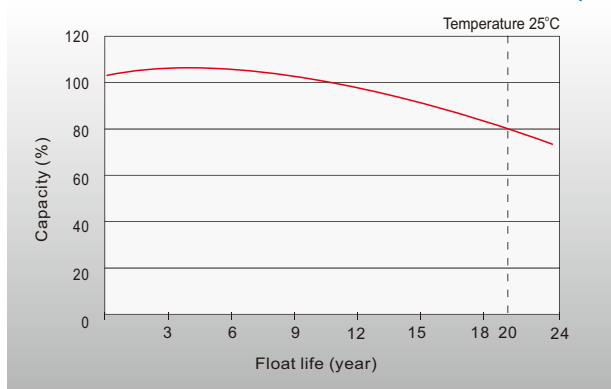

Sales Offices Worldwide

China Sales Office

5th Floor, Xinbaohui Bldg., Nanhai Blvd.,
Nanshan, Shenzhen, China. 518052
Tel: +86-755-86036060 (100 lines)
Fax: +86-755-26067269
E-mail: export@leoch.com

HongKong Sales Office

Workshop C, 33/F, TML Tower, No. 3 Hoi Shing Road,
Tsuen Wan, New Territories, Hong Kong
Tel: +852 35786666
Fax: +44 1452 690125
E-mail: sales.hk@leoch.com

Singapore Sales Office

No. 1 Tech Park Crescent,
Singapore 638131
Tel: +65 68636078
Fax: +65 6863 6079
Email: sales.sg@Leoch.com

Australia Sales Office

2 /29 Tarlington Place, Smithfield. NSW 2164
Australia
Tel: 02 9756 0950
E-mail: sales.au@leoch.com

North America Sales Office

19751 Descartes
Foothill Ranch, CA 92610, USA
Tel: 949-588-5853
Fax: 949-588-5966
E-mail: sales@leoch.us

UK Sales Office

9B Wheatstone Court, Waterwells, Business Park,
Gloucester, GL2-2AQ, UK United Kingdom
Tel: +44(0) 1452 729428 / 1452 729696
Fax: +44 1452 690125
E-mail: Sales.Europe@leoch.com

EMEA Sales Office

1 Deligiorgi St., 121 31 Athens,
Greece
Tel: +30 210 5760318 (2 lines)
E-mail: support_EMEA@leoch.com

India Sales Office

Shed no. A-53(b), 2nd Stage of Peenya Industrial Area,
Bangalore North Taluk, Bangalore-560058, India
Tel: +91-80-23440018/23440019
Fax: +91-80-23440017
E-mail: indiasales@leoch.com



[Http://www.leoch.com](http://www.leoch.com)
[Http://www.leoch.us](http://www.leoch.us)

© 2021 LEOCH. All rights reserved.
Trademarks and logos are the property of LEOCH and its affiliates unless otherwise noted.
Subject to revisions without prior notice.

Publication No.: LB-PLH90FT(A)-PD-EN-V3.5-202212