

FLOODED BATTERY

86-520 (12V60Ah)



CHARACTERISTICS

Item	Specifications	
Nominal Voltage	12V	
Nominal Capacity (20HR)	60Ah	
Reserve Capacity	98min	
Cold Cranking Amps@0°F (-18°C)	520A	
Dimension	Length	229mm (9.02inches)
	Width	171mm (6.73inches)
	Height	205mm (8.07inches)
Approx Weight	14.5kg (32.0lbs)	
Terminal	1	
Cell layout	1	
Hold-Down	B01	
Case	Black-PP Material	
Cover	Black-PP Material	
Handle	TS3	

APPLICATIONS

- Car start
- EV/HEV
- Engine start

GENERAL FEATURES

- High capacity and high CCA
- Long life
- Advanced lead-calcium alloy technology, maintenance-free design
- Patented venting system bring less water loss and prevent acid leakage
- OE quality certification

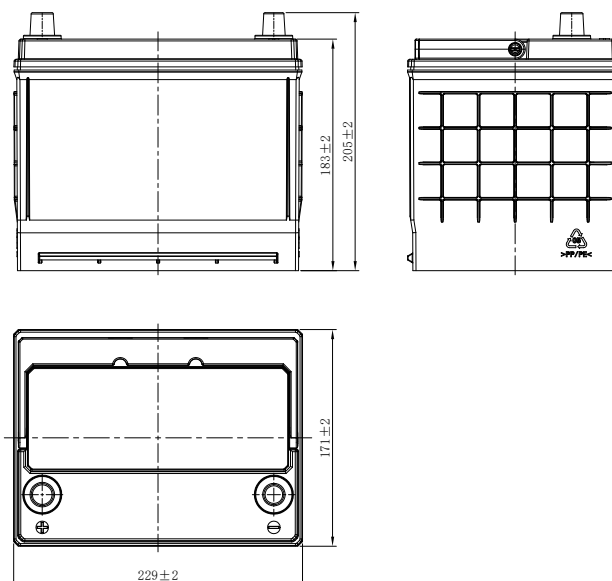
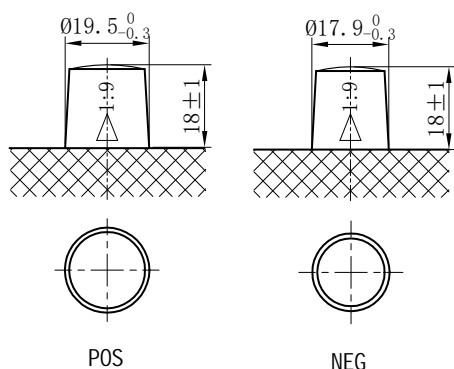

*Values are subject to variation of +/- 5% in normal manufacturing processes.

Leoch International Technology Ltd.
www.leoch.com

Leoch Batteries Pte Ltd
www.leoch.sg

Leoch Battery Corporation
www.leochamericas.com

Leoch Europe S.A.
www.leoch.eu