

LAWN MOWER BATTERY

U1L-300 (12V23Ah)



CHARACTERISTICS

Item	Specifications	
Nominal Voltage	12V	
Nominal Capacity (20HR)	23Ah	
Reserve Capacity	32min	
Cold Cranking Amps@0°F (-18°C)	300A	
Dimension	Length	196mm (7.72inches)
	Width	132mm (5.20inches)
	Height	185mm (7.28inches)
Approx Weight	7.7kg (17.0lbs)	
Terminal	4	
Cell layout	1	
Hold-Down	B0	
Case	Black-PP Material	
Cover	Black-PP Material	
Handle	TS9	

APPLICATIONS

- Garden Tractors
- Lawn Tractors

GENERAL FEATURES

- Design for lawn mower
- Extreme start ability and high capacity
- Absolutely maintenance-free
- Leakage and spill proof
- Vibration resistance
- Long service life

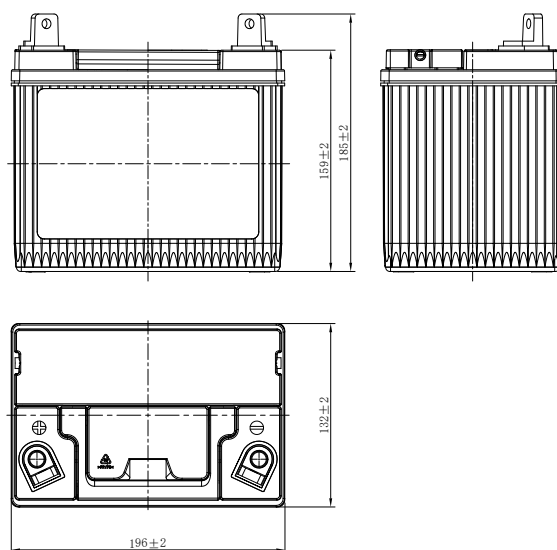
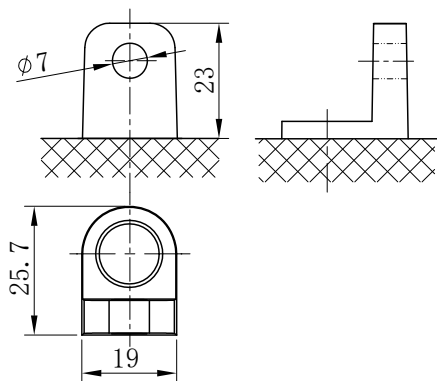

*Values are subject to variation of +/- 5% in normal manufacturing processes.

Leoch International Technology Ltd.
www.leoch.com

Leoch Batteries Pte Ltd
www.leoch.sg

Leoch Battery Corporation
www.leochamericas.com

Leoch Europe S.A.
www.leoch.eu