

# LAWN MOWER BATTERY

U1R-250 (12V20Ah)



## CHARACTERISTICS

Item	Specifications	
Nominal Voltage	12V	
Nominal Capacity (20HR)	20Ah	
Reserve Capacity	24min	
Cold Cranking Amps@0°F (-18°C)	250A	
Dimension	Length	196mm (7.72inches)
	Width	132mm (5.20inches)
	Container Height	159mm (6.26inches)
	Total Height (with Terminal)	185mm (7.28inches)
Approx Weight	7.4kg (16.3lbs)	
Terminal	4	
Cell layout	0	
Hold-Down	B0	
Case	Black-PP Material	
Cover	Black-PP Material	
Handle	TS9	

## APPLICATIONS

- Garden Tractors
- Lawn Tractors

## GENERAL FEATURES

- Design for lawn mower
- Extreme start ability and high capacity
- Absolutely maintenance-free
- Leakage and spill proof
- Vibration resistance
- Long service life

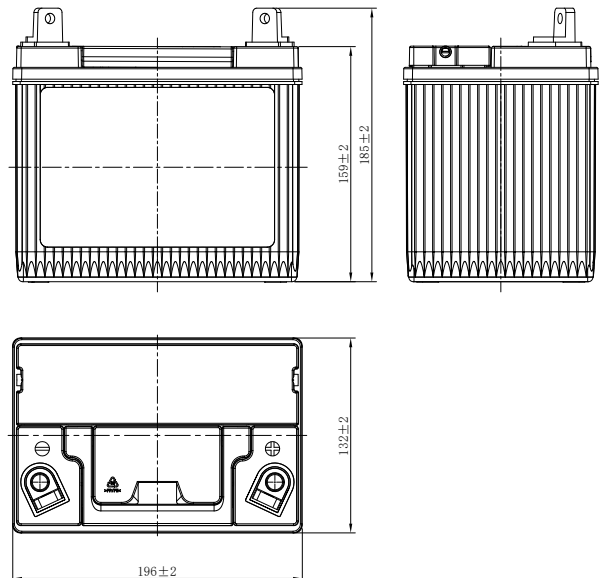
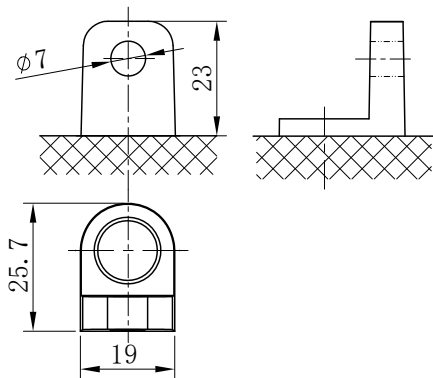

\*Values are subject to variation of +/- 5% in normal manufacturing processes.

Leoch International Technology Ltd.  
[www.leoch.com](http://www.leoch.com)

Leoch Batteries Pte Ltd  
[www.leoch.sg](http://www.leoch.sg)

Leoch Battery Corporation  
[www.leochamericas.com](http://www.leochamericas.com)

Leoch Europe S.A.  
[www.leoch.eu](http://www.leoch.eu)