

# FLOODED BATTERY

60044 (12V100Ah)



## CHARACTERISTICS

Item	Specifications	
Nominal Voltage	12V	
Nominal Capacity (20HR)	100Ah	
Reserve Capacity	179min	
Cold Cranking Amps@0°F (-18°C)	810A	
Dimension	Length	351mm (13.8inches)
	Width	174mm (6.85inches)
	Height	188mm (7.40inches)
Approx Weight	23.5kg (51.8lbs)	
Terminal	1	
Cell layout	0	
Hold-Down	B13	
Case	Black-PP Material	
Cover	Black-PP Material	
Handle	TS6	

## APPLICATIONS

- Car start
- EV/HEV
- Engine start

## GENERAL FEATURES

- High capacity and high CCA
- Long life
- Advanced lead-calcium alloy technology, maintenance-free design
- Patented venting system bring less water loss and prevent acid leakage
- OE quality certification

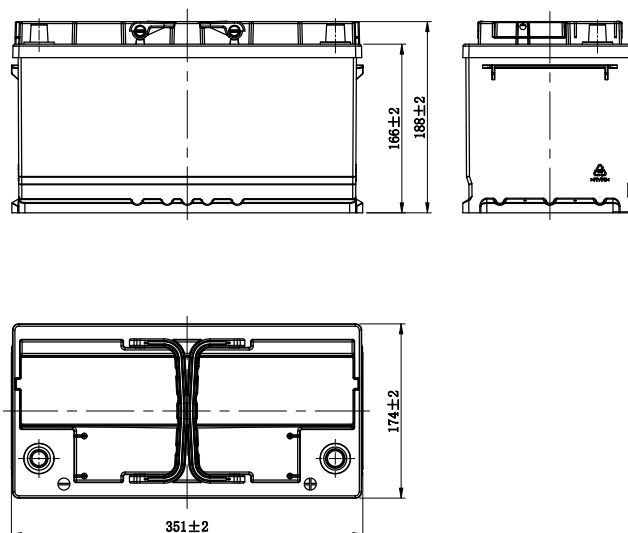
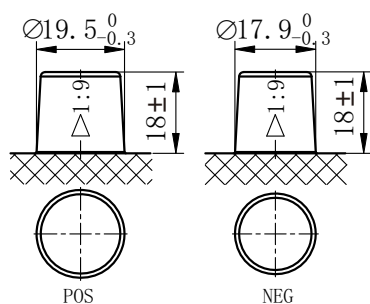

\*Values are subject to variation of +/- 5% in normal manufacturing processes.

Leoch International Technology Ltd.  
[www.leoch.com](http://www.leoch.com)

Leoch Batteries Pte Ltd  
[www.leoch.sg](http://www.leoch.sg)

Leoch Battery Corporation  
[www.leochamericas.com](http://www.leochamericas.com)

Leoch Europe S.A.  
[www.leoch.eu](http://www.leoch.eu)