

FLOODED HIGH TEMPERATURE BATTERY

46B24LHT (12V45Ah)



CHARACTERISTICS

Item	Specifications	
Nominal Voltage	12V	
Nominal Capacity (20HR)	45Ah	
Reserve Capacity	70min	
Cold Cranking Amps@0°F (-18°C)	350A	
Dimension	Length	236mm(9.29inches)
	Width	128mm(5.04inches)
	Height	222mm(8.74inches)
Approx Weight	11.7kg(25.8lbs)	
Terminal	3	
Cell layout	0	
Hold-Down	B0	
Case	Black-PP Material	
Cover	Black-PP Material	
Handle	TS1	

APPLICATIONS

- Car start
- EV/HEV
- Engine start

GENERAL FEATURES

- Design for high temperature countries and regions
- Superior life in high temperature environment
- High tin alloy and thicker positive grid
- High-temp paste
- Patented venting system bring less water loss and prevent acid leakage

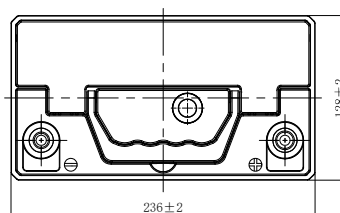
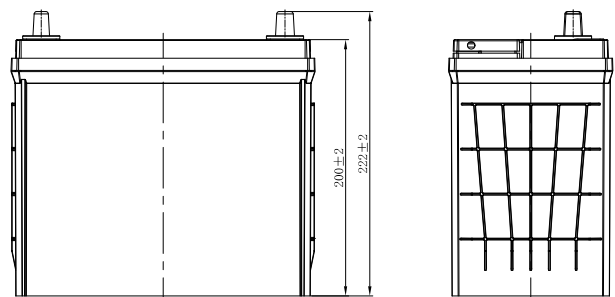
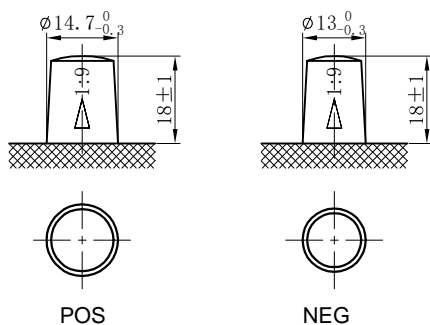

*Values are subject to variation of +/- 5% in normal manufacturing processes.

Leoch International Technology Ltd.

www.leoch.com

Leoch Batteries Pte Ltd

www.leoch.sg

Leoch Battery Corporation

www.leochamericas.com

Leoch Europe S.A.

www.leoch.eu

Data above is recommended and the picture is only for battery effect display, Leoch reserve the final right of explanation.
© LEOCH. All rights reserved. Trademarks and logos are the property of LEOCH and its affiliates unless otherwise noted. Subject to revisions without prior notice. E&OE.

Publication No.:LB-46B24LHT-PD-EN-V1.0-20250220