

FLOODED HIGH TEMPERATURE BATTERY

46B24LHT (12V45Ah)



CHARACTERISTICS

Item	Specifications	
Nominal Voltage	12V	
Nominal Capacity (20HR)	45Ah	
Reserve Capacity	70min	
Cold Cranking Amps@0°F (-18°C)	350A	
Dimension	Length	236mm (9.29inches)
	Width	128mm (5.04inches)
	Height	222mm (8.74inches)
Approx Weight	11.7kg (25.8lbs)	
Terminal	3	
Cell layout	0	
Hold-Down	B0	
Case	Black-PP Material	
Cover	Black-PP Material	
Handle	TS1	

APPLICATIONS

- Car start
- EV/HEV
- Engine start

GENERAL FEATURES

- Design for high temperature countries and regions
- Superior life in high temperature environment
- High tin alloy and thicker positive grid
- High-temp paste
- Patented venting system bring less water loss and prevent acid leakage

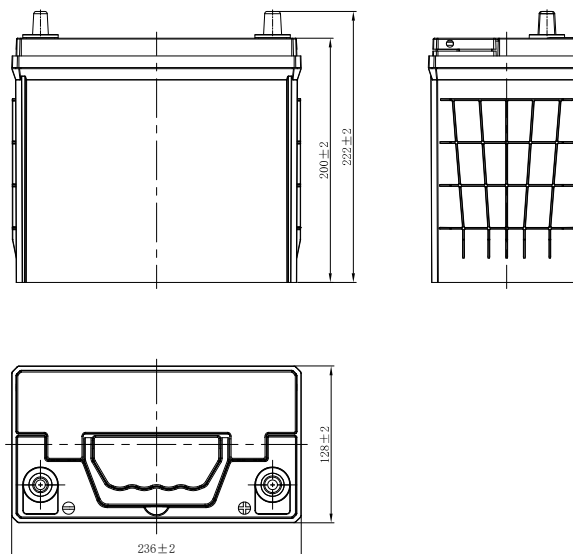
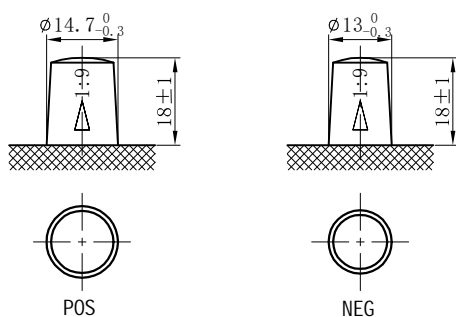

*Values are subject to variation of +/- 5% in normal manufacturing processes.

Leoch International Technology Ltd.
www.leoch.com

Leoch Batteries Pte Ltd
www.leoch.sg

Leoch Battery Corporation
www.leochamericas.com

Leoch Europe S.A.
www.leoch.eu