

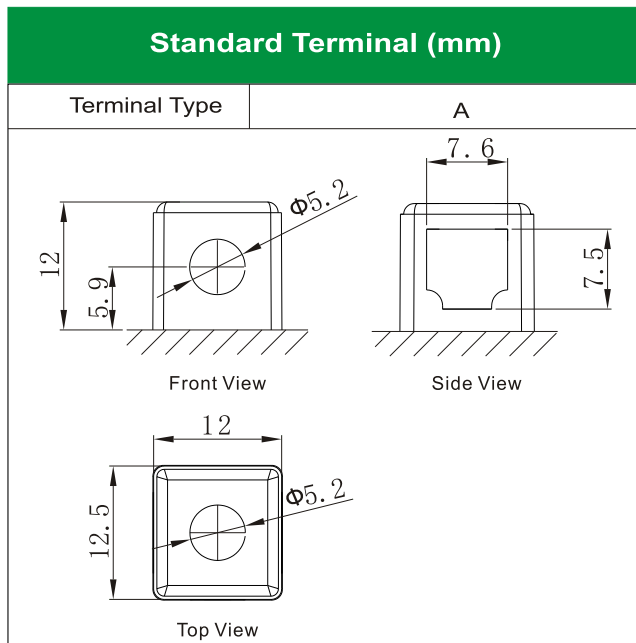

LEOCH BATTERY
HPG7-3 (12V6Ah)

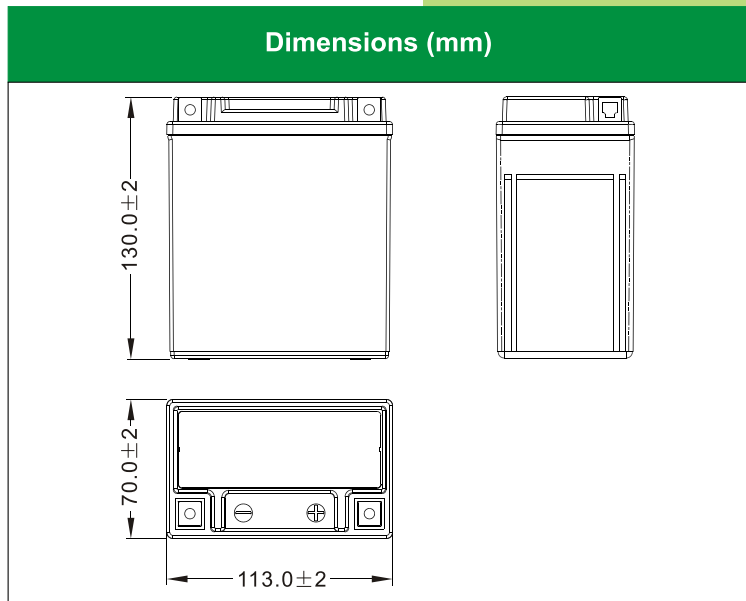

Physical Specification

Nominal Voltage	12V	
Nominal Capacity (10HR)	6Ah	
Dimension	Length	113±2mm (4.45 inches)
	Width	70±2mm (2.76 inches)
	Container Height	130±2mm (5.12 inches)
	Total Height (with Terminal)	130±2mm (5.12 inches)
Weight	Battery(with acid): Approx 2.35kg (5.18lbs) Electrolyte: Approx 0.44kg (0.97lbs)	

- * 100% leak-proof and spill-proof to 360°
- * Totally Maintenance-free
- * Longer lifespan
- * Lower self discharge
- * Powerful 85 cold cranking amps
- * Shipped pre-charged and ready to install
- * Replaces LT7-3 battery

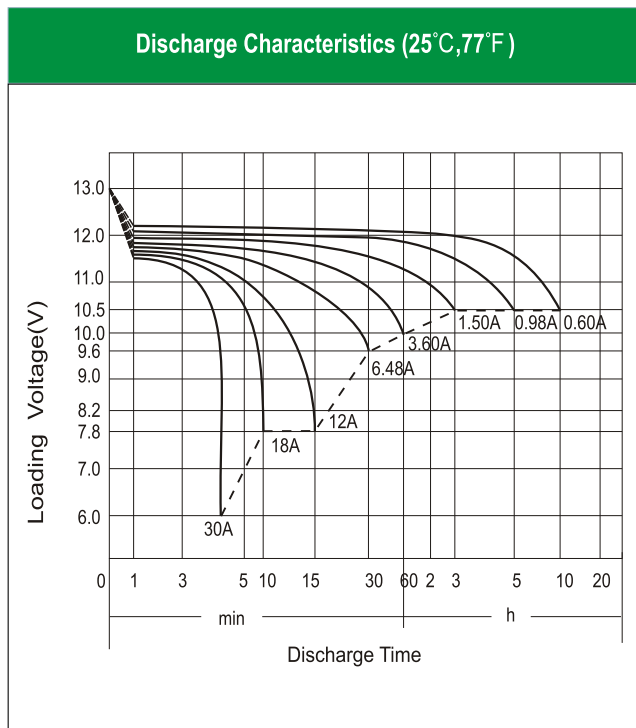

Electrical Specification

Rated Capacity	10 hour rate (0.60 A)	6.00Ah
	5 hour rate (0.98 A)	4.92Ah
	2 hour rate (2.10 A)	4.20Ah
	1 hour rate (3.60 A)	3.60Ah
	0.5 hour rate (6.48 A)	3.24Ah
Capacity affected by Temperature	40 °C (104 °F)	106%
	25 °C (77 °F)	100%
	0 °C (32 °F)	86%
	-15 °C (5 °F)	65%
Charging Methods	Full Charge	Constant-Voltage Charge: Initial charging current: less than 1.8A Voltage: 14.40 V ~ 15.00 V at 25 °C (77 °F) Charging time: 15 ~18h Constant-Current Charge: Charging current: 0.1C ₁₀ =0.60A, when charging voltage up to 14.40V, continue to charge 4h
	Floating Charge	No limit on Initial charging current Voltage: 13.50 V ~ 13.80 V at 25 °C (77 °F)