

# CONVENTIONAL FLOODED MOTORCYCLE BATTERY

## 12N14-4A (12V14Ah)

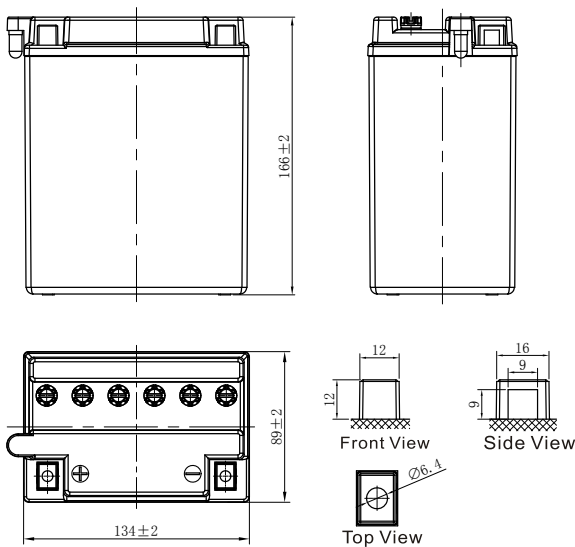

### GENERAL FEATURES

- Low maintenance
- High performance and dry charged high quality and flooded battery
- Shipped without battery electrolyte pre-charged and ready to install

### CHARACTERISTICS

Item	Specifications	
Nominal Voltage	12V	
Nominal Capacity (10HR)	14Ah	
Cold Cranking Performance Amps@0°F (-18°C)	128A	
Dimension (±2mm)	Length	134mm (5.28inches)
	Width	89mm (3.50inches)
	Container Height	166mm (6.54inches)
	Total Height	166mm (6.54inches)
Battery (with acid)	Approx Weight	4.19kg (9.24lbs)
Electrolyte	Approx Weight	1.17kg (2.58lbs)
Terminal type	D	
Battery type	Conventional Flooded Series	
Full Charge	Constant-Voltage Charge:	
	Initial charging current	Less than 0.3C <sub>10</sub>
	Voltage	14.40V~15.00V at 25°C (77°F)
	Charging time	16~24h
	Constant-Current Charge:	
	Charging current 0.1C <sub>10</sub> , when charging voltage up to 15.60V, continue to charge 2h	
Floating Charge	Initial charging current	Unlimited
	Voltage	13.50V~13.80V at 25°C (77°F)
Capacity affected by Temperature	40°C (104°F)	106%
	25°C (77°F)	100%
	0°C (32°F)	86%
	-15°C (5°F)	65%

### Discharge Characteristics (25°C, 77°F)

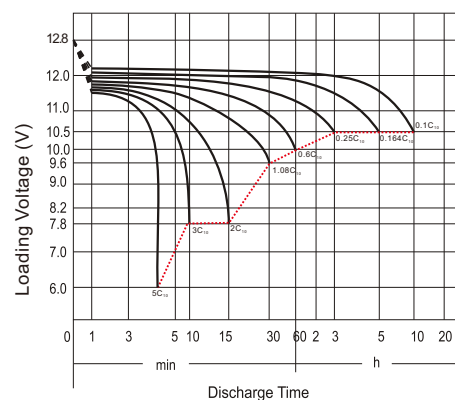

\*Values are subject to variation of +/- 5% in normal manufacturing processes.

Leoch International Technology Ltd.  
www.leoch.com

Leoch Batteries Pte Ltd  
www.leoch.sg

Leoch Battery Corporation  
www.leochamericas.com

Leoch Europe S.A.  
www.leoch.eu