

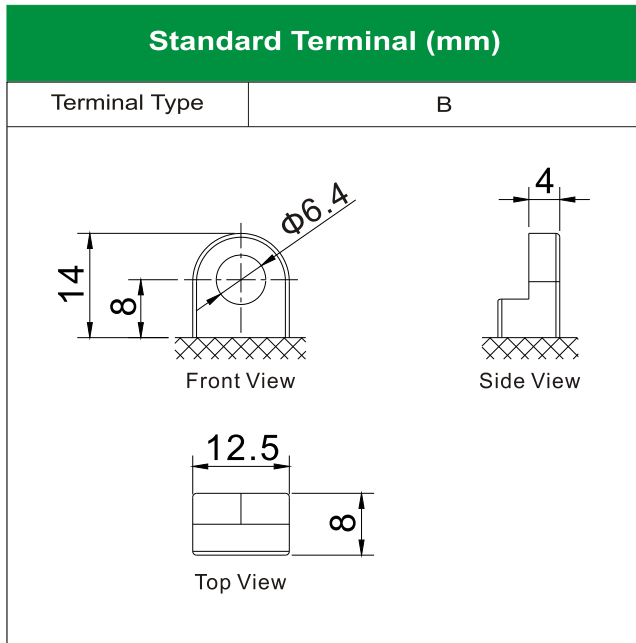

LEOCH BATTERY
12N7-4B [12V7Ah]

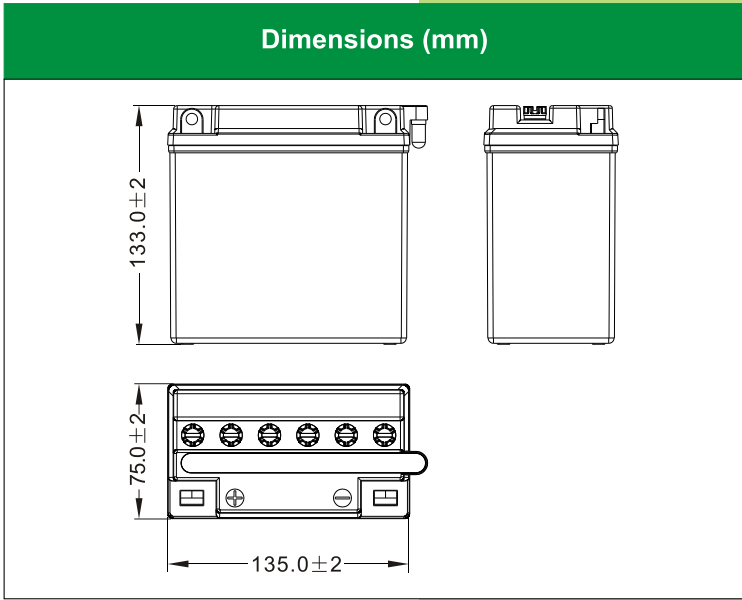
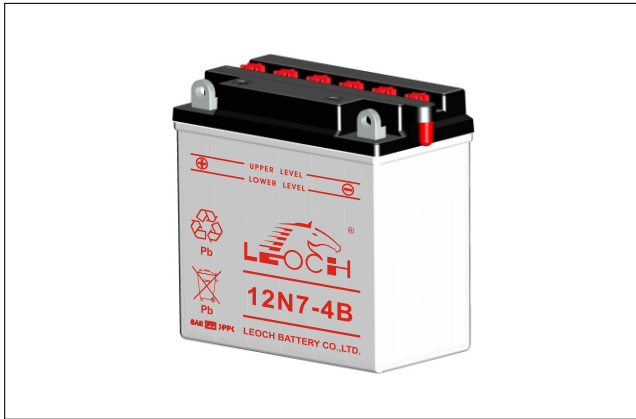

Physical Specification

Nominal Voltage	12V	
Nominal Capacity (10HR)	7Ah	
Dimension	Length	135 ± 2mm (5.31 inches)
	Width	75 ± 2mm (2.95 inches)
	Container Height	133 ± 2mm (5.24 inches)
	Total Height (with Terminal)	133 ± 2mm (5.24 inches)
Weight	Battery(with acid): Approx 2.86kg (6.31lbs)	
	Electrolyte: Approx 0.76kg (1.67lbs)	

- * High performance and dry charged high quality and flooded battery
- * Low maintenance
- * Powerful 74 cold cranking amps
- * Shipped without battery electrolyte pre-charged and ready to install
- * Replaces none battery

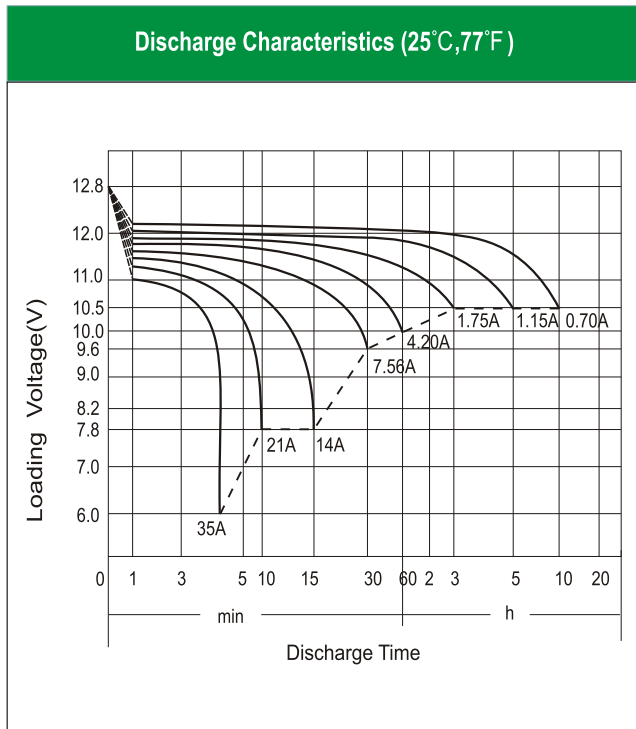

Electrical Specification

Rated Capacity	10 hour rate (0.70A)	7.00Ah
	5 hour rate (1.15 A)	5.74Ah
	2 hour rate (2.45A)	4.90Ah
	1 hour rate (4.20 A)	4.20Ah
	0.5 hour rate (7.56 A)	3.78Ah
Capacity affected by Temperature	40 °C (104 °F)	106%
	25 °C (77 °F)	100%
	0 °C (32 °F)	86%
	-15 °C (5 °F)	65%
Charging Methods	Full Charge	Constant-Voltage Charge: Initial charging current: less than 2.1A Voltage: 14.40 V ~ 15.00 V at 25 °C (77 °F) Charging time: 16 ~24h Constant-Current Charge: Charging current: 0.7A, when charging voltage up to 15.60V, continue to charge 2h.
	Floating Charge	No limit on Initial charging current Voltage: 13.50 V ~ 13.80 V at 25 °C (77 °F)