

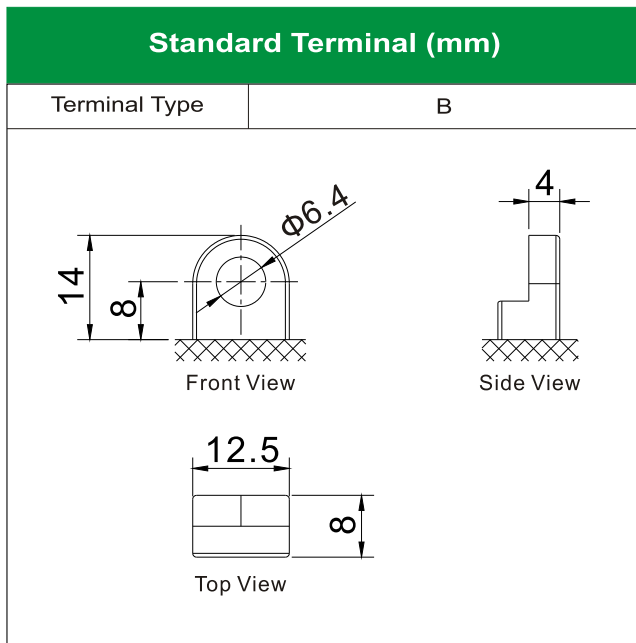

LEOCH BATTERY
B54-6A [6V12Ah]

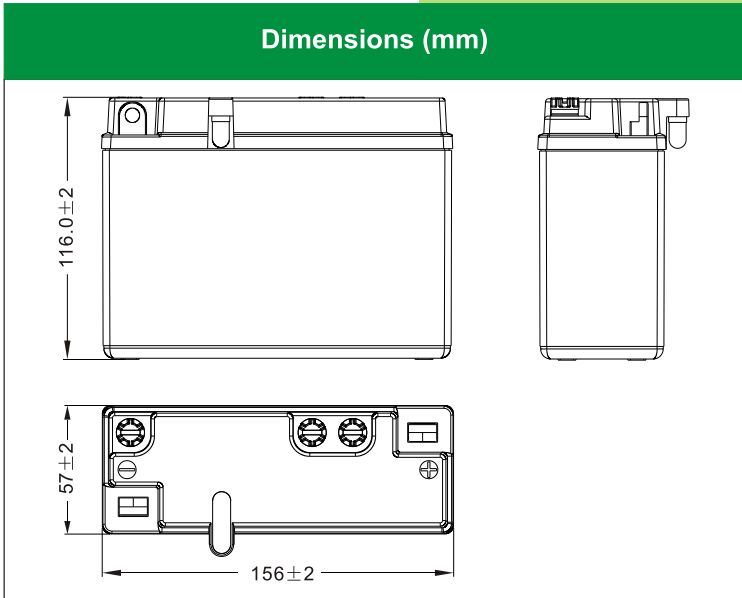

Physical Specification

Nominal Voltage	6V	
Nominal Capacity (10HR)	12Ah	
Dimension	Length	156 ± 2mm (6.14 inches)
	Width	57 ± 2mm (2.24 inches)
	Container Height	116 ± 2mm (4.57 inches)
	Total Height (with Terminal)	116 ± 2mm (4.57 inches)
Weight	Battery(with acid): Approx 2.14kg (4.72lbs)	
	Electrolyte: Approx 0.58kg (1.28lbs)	

- * High performance and dry charged high quality and flooded battery
- * Low maintenance
- * Shipped without battery electrolyte pre-charged and ready to install
- * Replaces none battery

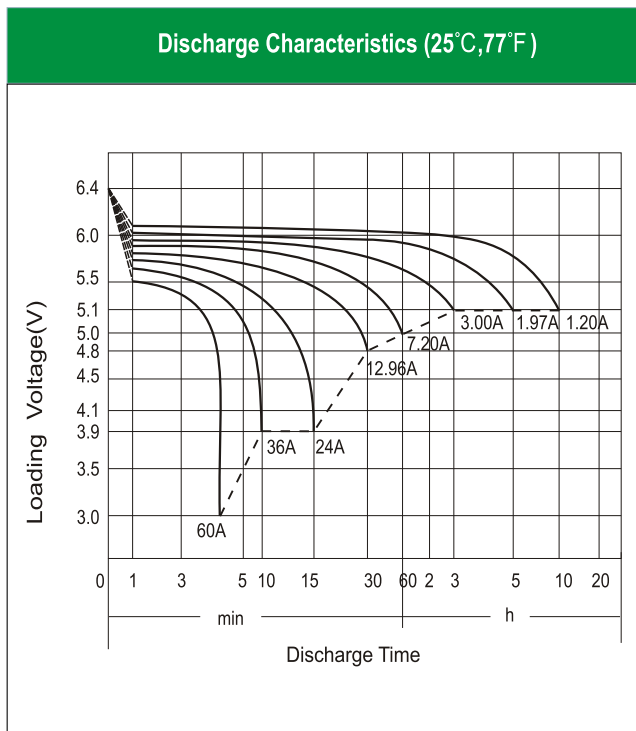

Electrical Specification

Rated Capacity	10 hour rate (1.20A)	12.00Ah
	5 hour rate (1.97A)	9.84Ah
	2 hour rate (4.20 A)	8.40Ah
	1 hour rate (7.20 A)	7.20Ah
	0.5 hour rate (12.96 A)	6.48Ah
Capacity affected by Temperature	40 °C (104 °F)	106%
	25 °C (77 °F)	100%
	0 °C (32 °F)	86%
	-15 °C (5 °F)	65%
Charging Methods	Full Charge	Constant-Voltage Charge: Initial charging current: less than 3.6A Voltage: 7.20 V ~ 7.50 V at 25 °C (77 °F) Charging time: 16 ~24h Constant-Current Charge: Charging current: 1.2A, when charging voltage up to 7.80V, continue to charge 2h.
	Floating Charge	No limit on Initial charging current Voltage: 6.75V ~ 6.90V at 25 °C (77 °F)