

MAINTENANCE-FREE MOTORCYCLE BATTERY

EBX14L-BS(J) (12V12Ah)

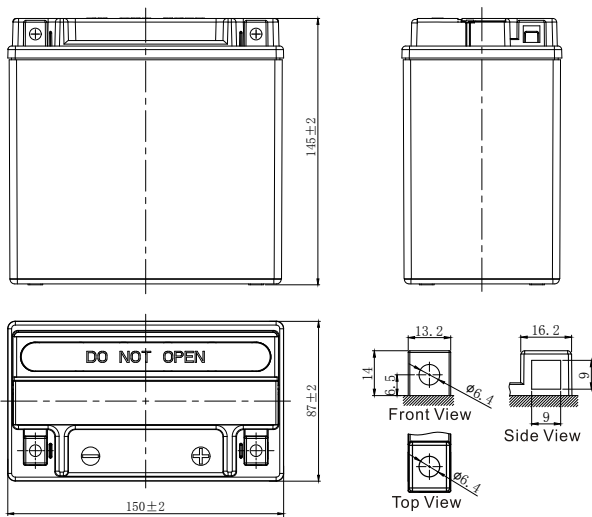

GENERAL FEATURES

- Sealed AGM battery
- Rest after filling acid
- Fresh Pack, Maintenance-Free

*Values are subject to variation of +/- 5% in normal manufacturing processes.

Leoch International Technology Ltd.
www.leoch.com

Leoch Batteries Pte Ltd
www.leoch.sg

Leoch Battery Corporation
www.leochamericas.com

Leoch Europe S.A.
www.leoch.eu

Data above is recommended and the picture is only for battery effect display, Leoch reserve the final right of explanation.
© LEOCH. All rights reserved. Trademarks and logos are the property of LEOCH and its affiliates unless otherwise noted. Subject to revisions without prior notice. E&OE.

CHARACTERISTICS

Item	Specifications	
Nominal Voltage	12V	
Nominal Capacity (10HR)	12Ah	
Cold Cranking Performance Amps@0°F (-18°C)	160A	
Dimension (±2mm)	Length	150mm (5.91inches)
	Width	87mm (3.43inches)
	Container Height	145mm (5.71inches)
	Total Height	145mm (5.71inches)
Battery (with acid)	Approx Weight	4.06kg (8.95lbs)
Electrolyte	Approx Weight	0.86kg (1.90lbs)
Terminal type	A	
Battery type	Dry Charged Series	
Full Charge	Constant-Voltage Charge:	
	Initial charging current	Less than 0.3C ₁₀
	Voltage	14.40V~15.00V at 25°C (77°F)
	Charging time	15~18h
	Constant-Current Charge:	
	Charging current 0.1C ₁₀ , when charging voltage up to 14.40V, continue to charge 4h	
Floating Charge	Initial charging current	Unlimited
	Voltage	13.50V~13.80V at 25°C (77°F)
	40°C (104°F)	106%
Capacity affected by Temperature	25°C (77°F)	100%
	0°C (32°F)	86%
	-15°C (5°F)	65%

Discharge Characteristics (25°C, 77°F)

