

# MAINTENANCE-FREE MOTORCYCLE BATTERY

## EBZ7L-BS (12V6Ah)

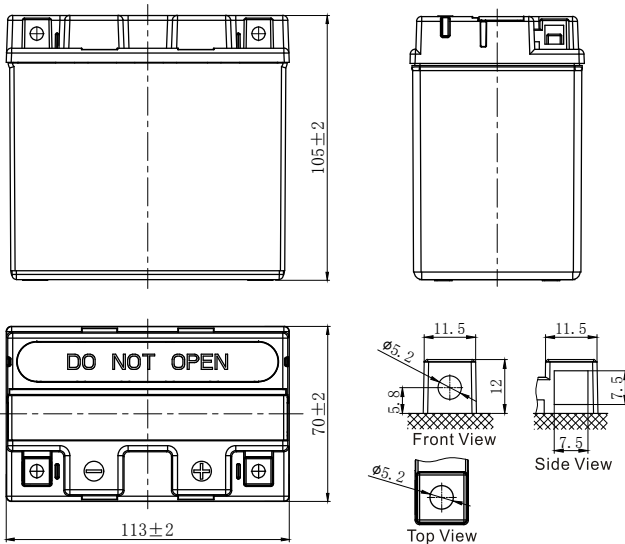
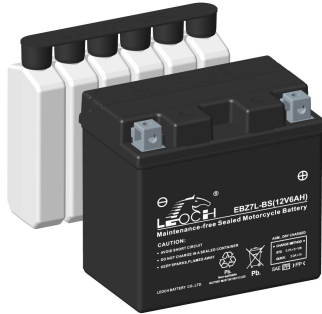

### GENERAL FEATURES

- Sealed AGM battery
- Rest after filling acid
- Fresh Pack, Maintenance-Free

\*Values are subject to variation of +/- 5% in normal manufacturing processes.

### CHARACTERISTICS

Item	Specifications	
Nominal Voltage	12V	
Nominal Capacity (10HR)	6Ah	
Cold Cranking Performance Amps@0°F (-18°C)	95A	
Dimension (±2mm)	Length	113mm (4.45inches)
	Width	70mm (2.76inches)
	Container Height	105mm (4.13inches)
	Total Height	105mm (4.13inches)
Battery (with acid)	Approx Weight	2.14kg (4.72lbs)
Electrolyte	Approx Weight	0.37kg (0.816lbs)
Terminal type	A	
Battery type	Dry Charged Series	
Full Charge	Constant-Voltage Charge:	
	Initial charging current	Less than 0.3C <sub>10</sub>
	Voltage	14.40V~15.00V at 25°C (77°F)
	Charging time	15~18h
	Constant-Current Charge:	
	Charging current 0.1C <sub>10</sub> , when charging voltage up to 14.40V, continue to charge 4h	
Floating Charge	Initial charging current	Unlimited
	Voltage	13.50V~13.80V at 25°C (77°F)
	Capacity affected by Temperature	
Capacity affected by Temperature	40°C (104°F)	106%
	25°C (77°F)	100%
	0°C (32°F)	86%
	-15°C (5°F)	65%

### Discharge Characteristics (25°C, 77°F)

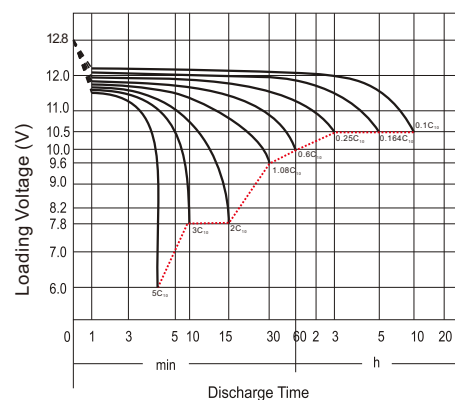

Leoch International Technology Ltd.  
www.leoch.com

Leoch Batteries Pte Ltd  
www.leoch.sg

Leoch Battery Corporation  
www.leochamericas.com

Leoch Europe S.A.  
www.leoch.eu