

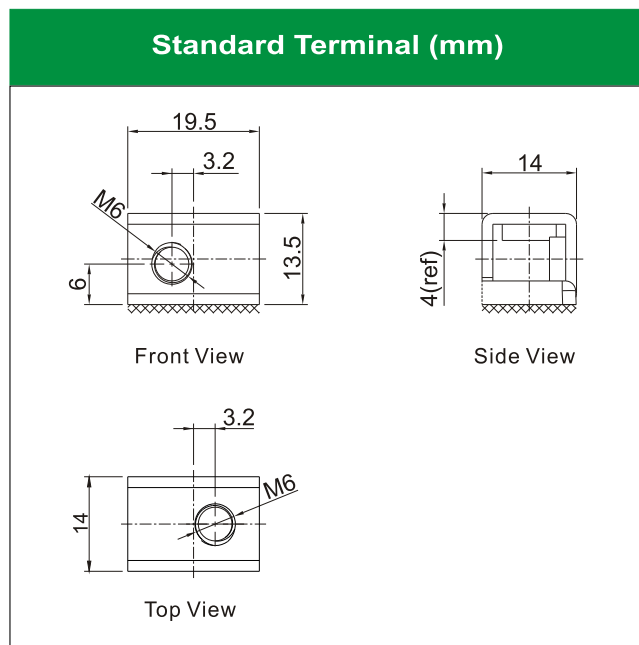

LEOCH BATTERY

MX18-3 [12V20Ah]

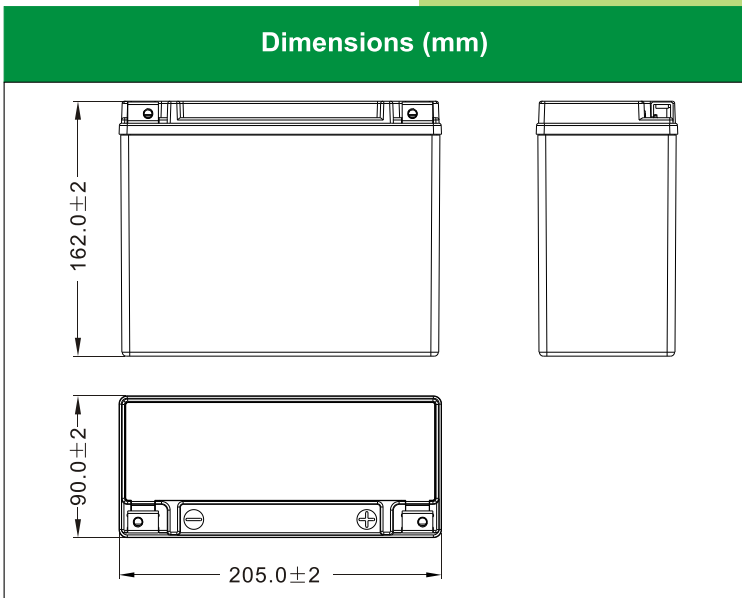

Physical Specification

Nominal Voltage		12V
Nominal Capacity (10HR)		20Ah
Dimension	Length	205 ± 2mm (8.07 inches)
	Width	90 ± 2mm (3.54 inches)
	Container Height	162 ± 2mm (6.38 inches)
	Total Height (with Terminal)	162 ± 2mm (6.38 inches)
Weight	Battery(with acid): Approx 7.50kg (16.54lbs)	
	Electrolyte: Approx 1.5kg (3.3lbs)	

- * Sealed and non-spillable AGM battery
- * Maintenance-free
- * Powerful 340 cold cranking amps
- * Shipped pre-charged and ready to install

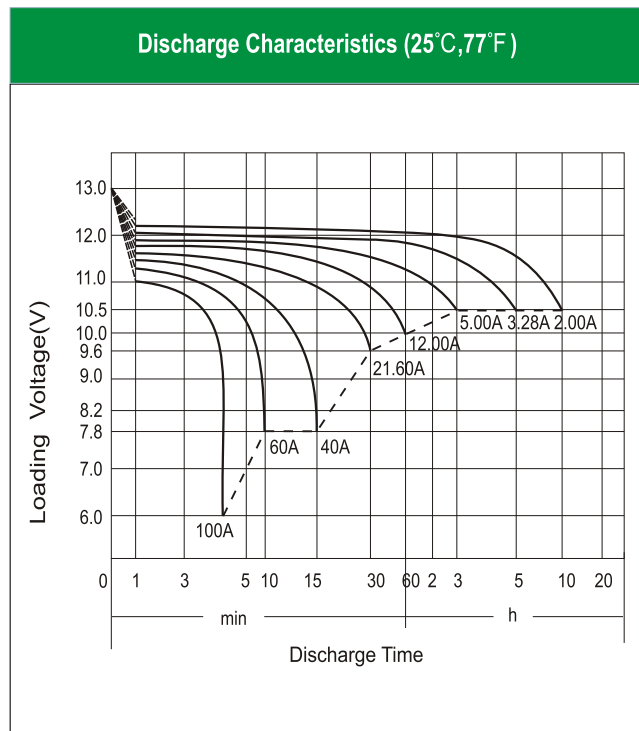

Electrical Specification

Rated Capacity	10 hour rate (2.00 A)	20.0Ah
	5 hour rate (3.28 A)	16.4Ah
	2 hour rate (7.00 A)	14.0Ah
	1 hour rate (12.0 A)	12.0Ah
	0.5 hour rate (21.6 A)	10.8Ah
Capacity affected by Temperature	40 °C (104 °F)	106%
	25 °C (77 °F)	100%
	0 °C (32 °F)	86%
	-15 °C (5 °F)	65%
Charging Methods	Full Charge	Constant-Voltage Charge: Initial charging current: less than 6.0A Voltage: 14.40 V ~ 15.00 V at 25 °C (77 °F) Charging time: 15 ~18h Constant-Current Charge: Charging current: 0.1C ₁₀ =2.0A, when charging voltage up to 14.40V, continue to charge 4h
	Floating Charge	No limit on Initial charging current Voltage: 13.50 V ~ 13.80 V at 25 °C (77 °F)